

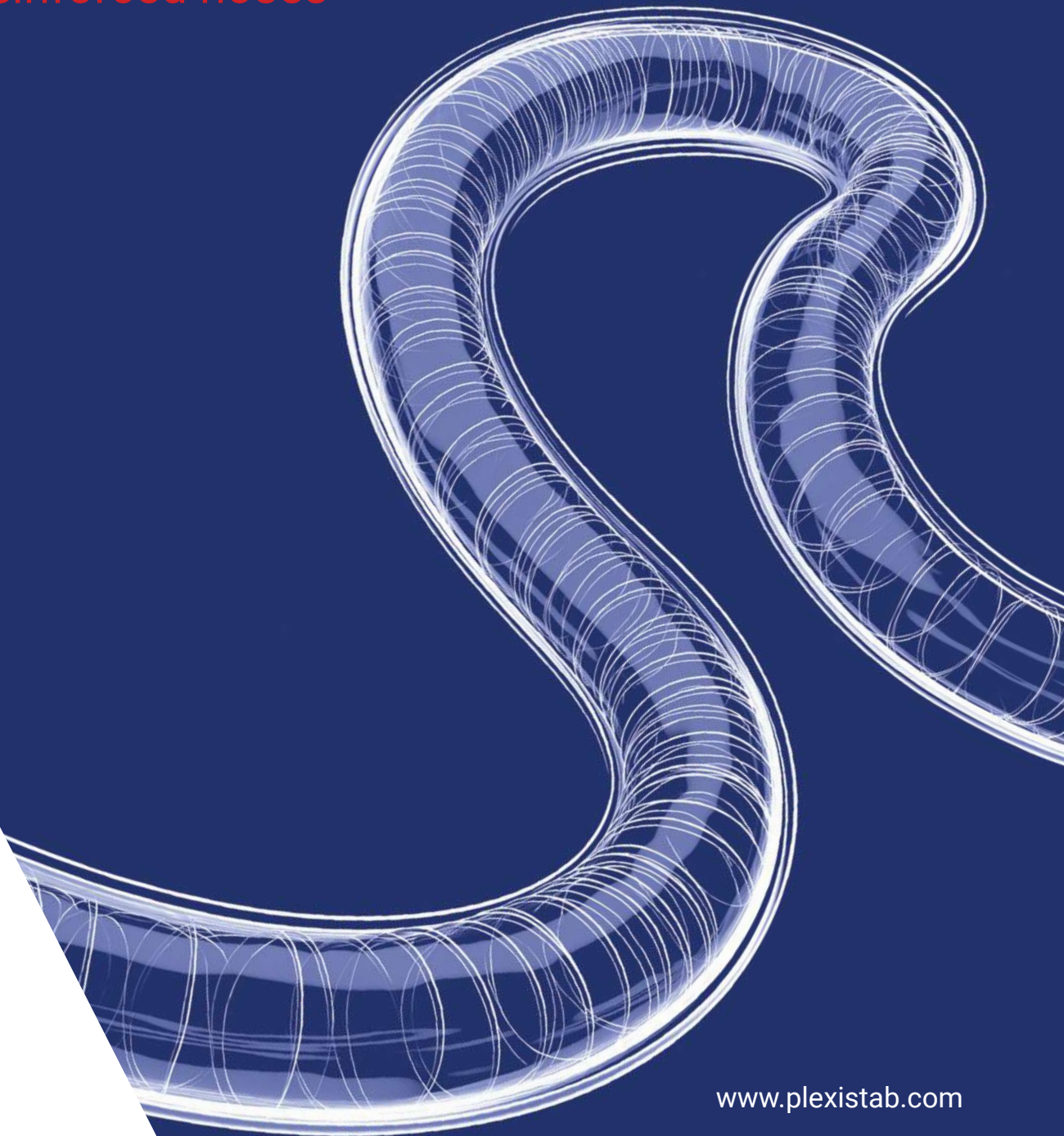

Catalogue

PVC reinforced hoses



www.plexistab.com

Our story

Back in 2000, the fast-growing family business Stabil Engineering, Bulgaria teamed up with the world's leading PVC hose producer at that time, Plexaco, Greece. The result of this cooperation is Plexistab – a progressive, family-owned business with solid expertise and know-how, gained through years of working with and learning from the best.

During our partnership, we have expanded our knowledge of technology and production, polished our technical skills, and built-up management experience that, up to this date, guarantee the high quality of our products.

And just as any other family, Plexistab kept growing and evolving over the years. New and different opportunities came our way that drove our continuous thirst for learning and improvement. We dedicated plenty of time, enthusiasm, and hard work to the “project” Plexistab, Bulgaria. As a result, we built a strong technical and production team, which now ensures our rapid future development.

Plexistab today

In 2012 it was time for Plexistab to become independent. The company became 100% Bulgarian owned and since then has been part of Stabil Group – a family holding of six companies with diversified activities that spread across local and international markets but united by true family values. With such solid foundations, we have managed to triple our production capacity by ongoing investment in production lines and infrastructure including:

- More than **7000 m² industrial land**;
- **4454 m² of modern buildings**, specially designed for the production and storage of PVC reinforced hoses;
- Production capacity of **3000 t/year on 11 production lines**;
- A clear export orientation with **89% of production sold worldwide**.



New leadership – new horizons

As a family, we grow and progress together. That is why we also firmly believe in the natural process of development and exploration of new horizons and new opportunities. We follow the tradition of learning from the experienced, adding knowledge and value, and embracing the enthusiasm and vision of the new generations. Team, which now ensures our rapid future development.



”



“Our way of doing business is inspired by true family relations and everlasting strive to improvement and innovation. We have built a strong technical and production team, which makes our future advancement possible every single day. But our main priority has always been our customers, meaning you. Our relationship with you, your satisfaction, your client’s satisfaction and the growth of your business.”

Bilyana Kutseva | Executive Director



“Our strength comes from our family focus. Our whole family has put their life into this company and we will continue with the same devotion in the years to come. But also, our employees, our customers have become part of this family and we look into our common future together, with shared goals, united by partnership. Tradition and knowledge mixed with modern tools for efficiency and expansion is our formula for success.”

Miryana Dzhebyan | Executive Director

MISSION

Growing together - one hose at a time

VISION

- What?** We want to be the preferred supplier for our international client base.
- How?** By offering a complete assortment with high quality products, best class service and a high level of professionalism in all aspects of our business.
- Why?** Through this approach, we will reach a podium position in our markets and offer continuity and success for our clients, employees and shareholders alike.

VALUES

FLEXIBLE

- We are fast and effective problem solvers.
- We are responsive to change in order to satisfy our clients' needs.
- We are flexible in our assortment and services.

RELIABLE

- We are pro-active and we keep our promises to clients and to our employees.
- We offer On Time and In Full service.

DURABLE

- We offer job security & personal growth opportunities for our employees.
- We deliver quality products to our clients.
- We build long lasting partnerships.

We are made to create

We have a strong, ambitious, and close-knit team which works on delivering the best products, separated in four main categories by brand: BULFLEX (Spiral Reinforced Flexible Hoses), BULVYL (Polyester Yarn Reinforced Braided Hoses), BULSTEEL (Metal Spiral Reinforced Flexible Hoses) and BULFLAT (Double Layer PVC Layflat Hoses).

Our products are consumables, with various application in different fields and industries, including:

- Agriculture
- Ventilation
- Technical
- Construction
- Food Quality



We work together

Our main priority has always been our customers, meaning you. We aim to ensure first, your and your customers' satisfaction and second, your sustainable business growth. That is why we strive to create long-lasting relations with our customers and mutually beneficial business partnerships. We have reached a 10-year history with many of our customers, which is both a great achievement and a solid stepstone for a successful and healthy common growth strategy.

We make sure that our commercial and logistics team is able to maintain a close contact with all our partners in many languages, like: Bulgarian - English - Russian - German - Spanish.

We reach beyond borders

Plexistab is the leading manufacturer of PVC hoses on the Eastern European market and as such, we are always looking for new opportunities and potential market expansion. So far, we have achieved 89% export of our production in more than 25 countries worldwide and on 4 continents.

Quality guarantee

At Plexistab Bulgaria we have guaranteed quality for both our products and the effectivity of our processes.

We strictly comply with all EU plastics regulations, ensuring that all our products are produced with material, which complies with the RoHS and REACH substance restrictions. Also, we constantly monitor our products with special applications, whether Food Quality or UV protection, at independent outside laboratories. Multiple certifications are available for our customers upon request.

Last, but not least, we apply the standards of ISO 9001:2015 both to the Quality Management of our products and to our processes of internal communication, customer service and delivery, which have always been our number one priority. This is why all the technical product data in this catalogue is guaranteed.



Lean - a new era in production

Since innovation is part of our DNA, we have embarked on a new journey in search for efficiency and quality in production. We have taken the first steps towards adopting a LEAN production model that encompasses elimination of all waste elements, practices, and processes that do not bring any market value. By embracing the LEAN methodology throughout all the structures of our company, we aim at becoming:

- More flexible and adaptive to the market;
- More sustainable and economic in our production;
- More efficient in our day-to-day work;
- And more modern and progressive in our collective mindset.



Contents



Agriculture

008N	Water & Liquids Delivery Hose.....	16
008S	Superelastic Water & Liquids Delivery Hose.....	18
011N	Water & Liquids Suction & Delivery Hose.....	20
011S	Superelastic Water & Liquids Suction & Delivery Hose.....	22
010N	Liquids and Abrasives Suction & Delivery Hose.....	24
010S	Superelastic Liquids and Abrasives Suction & Delivery Hose.....	26
006Z	Flexible Agro Hose.....	28
302N	PVC Braided Garden Hose.....	30
204N	Double Layer PVC Layflat Hose.....	32
206N	Double Layer PVC Layflat Hose.....	34
208N	Double Layer PVC Layflat Hose.....	36



Ventilation

130N	Cable Protection Hose.....	40
131W	Air Conditioner Drain Hose.....	42
120N	Air, Fume and Dust Ventilation Hose.....	44
161N	Vacuum Ventilation Hose.....	46



Technical









330M	Pressure Spray Braided Hose 20 bar.....	50
340N	Pressure Spray Braided Hose 30 bar.....	52
380N	Pressure Spray Braided Hose 50 bar.....	54
210N	Double Layer PVC Layflat Hose.....	56
216N	Double Layer PVC Layflat Hose.....	58



Construction

015S	Superelastic Slurry Hose.....	62
-------------	-------------------------------	----

015SSM	Extreme Elastic Slurry Hose	64
010SSZ	Extreme Elastic Suction Hose	66
021N	Liquids and Abrasives Heavy Suction & Delivery Hose.....	68
032N	Oil Resistant Suction & Delivery Hose.....	70
180G	Poolflex Heavy Duty	72
181G	Poolflex	74
170M	Pond Hose	76
	Food Quality	
007N	Food Quality Suction & Delivery Hose.....	80
042NP	Food Quality Suction & Delivery Hose.....	82
022NP	Food Quality Suction & Delivery Hose.....	84
320N	Food Quality Clear Braided Hose.....	86
501N	Food Quality Suction & Delivery Hose.....	88
600N	Cristal Hose Food Quality	90

	Production code	Code de production Codigo de producción	Produktionskode Производственный код
	Inside diameter	Diamètre interieur Diámetro interno	Innendurchmesser Внутренний диаметр
	Outside diameter	Diamètre extérieur Diámetro exterior	Aussendurchmesser Наружный диаметр
	Weigh	Poids Peso	Gewicht Вес
	Pressure	Pression Presión	Druck Рабочее давление
	Bursting pressure	Pression d'éclatement Presión de estallido	Platzdruck Разрывное давление
	Vacuum	Vide Vacío	Vakuum Вакуум
	Bending radius	Rayon de courbure Radio de curvatura	Biegeradius Радиус изгиба
	Coil length	Longueur de la bobine Longitud de la bobina	Länge der Verkaufsrolle Бухта



Agriculture

Agriculture | Agricultura
Landwirtschaft | Сельское хозяйство

008N Water & Liquids Delivery Hose



- FR** Tuyau d'aspiration et de transport pour eau et liquides
- ES** Manguera de Succión y Suministro de Agua y Líquidos
- DE** Wasser & Flüssigkeiten Saug- und Förderschlauch
- RU** Напорно-всасывающий шланг для воды и и других жидкостей



-10°C | +60°C
TEMPERATURE RANGE

- EN** This hose can be used for suction and delivery of water and other liquids in Agriculture or Construction.
- FR** Ce tuyau peut être utilisé comme un tuyau d'aspiration et de transport pour eau et d'autres liquides dans l'agriculture et la construction.
- ES** Esta manguera se puede utilizar para la succión y la entrega de agua y otros líquidos en la agricultura o la construcción.
- DE** Dieser Schlauch kann zum Ansaugen und Fördern von Wasser und anderen Flüssigkeiten in der Landwirtschaft oder im Bauwesen verwendet werden.
- RU** Этот шланг можно использовать для всасывания и транспортировки воды и других жидкостей в сельском хозяйстве и строительстве.

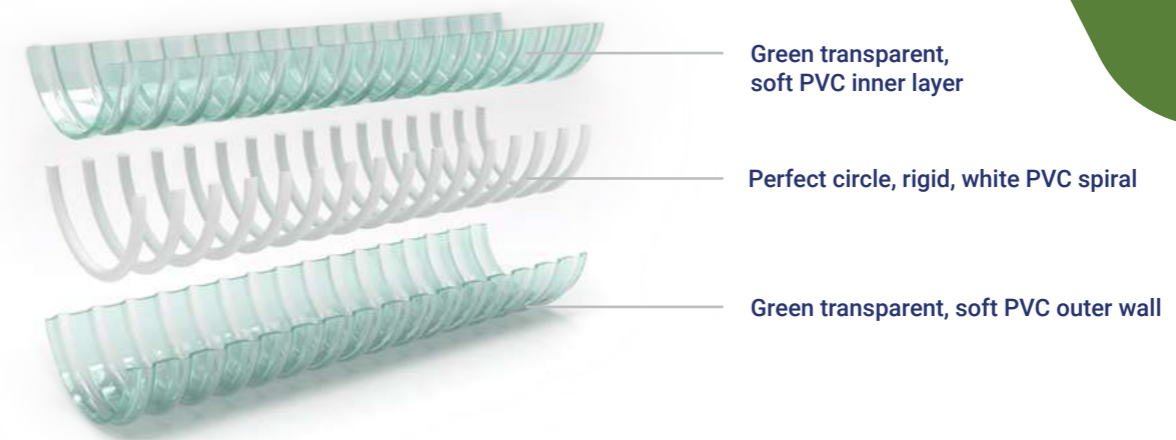

code	inch	mm	gr/m	bar	mbar	mm	m
F008N013	1/2	13	115	9	650	52	25/30/50
F008N016	5/8	16	145	9	650	64	25/30/50
F008N019	3/4	19	185	8	650	76	25/30/50
F008N020		20	195	8	650	80	25/30/50
F008N025	1	25	230	7	650	100	25/30/50
F008N030		30	280	7	650	120	25/30/50
F008N032	1 1/4	32	290	6	650	128	25/30/50
F008N035		35	440	6	650	140	25/30/50
F008N038	1 1/2	38	440	6	650	152	25/30/50
F008N040		40	520	5,5	650	160	25/30/50
F008N045	1 3/4	45	570	5	650	180	25/30/50
F008N051	2	51	690	5	650	200	25/30/50
F008N055		55	740	5	650	220	25/30/50
F008N060		60	800	5	650	240	25/30/50
F008N063	2 1/2	63	890	5	650	252	25/30/50
F008N070	2 3/4	70	1020	4	650	280	25/30/50
F008N076	3	76	1120	4	650	300	25/30/50
F008N080		80	1345	4	650	345	25/30/50
F008N090	3 1/2	90	1500	3	650	375	25
F008N102	4	102	1700	3	650	429	25

* **Working and bursting pressure valid at 20°C** / Pression de fonctionnement et limite, à 20°C / Pression de fonctionnement et limite, à 20 ° C / Betriebsdruck und Berstdruck gültig bei 20°C / Рабочее давление и разрывное давление, при 20°C
 ** **Length tolerance +/- 5%** / Tolérance de longueur +/- 5% / Tolerancia de longitud +/- 5% / Längentoleranz +/- 5% / Допуск длины +/- 5%
 *** **Inner Diameter tolerance +/- 2%** / Tolérance de diamètre interne +/- 2% / Tolerancia del diámetro interno +/- 2% / Toleranz des inneren Durchmessers +/- 2% / Допуск внутреннего диаметра +/- 2%

• Other colors are available against MOQ
 • Autres couleurs et longueurs sont disponibles avec la quantité minimale d'un ordre
 • Se ofrecen otros colores y longitudes contra una cantidad mínima de pedido
 • Andere Farben sind gegen Mindestbestellmenge erhältlich
 • В другом цвете возможен при соблюдении минимальных количеств к заказу



008S Superelastic Water & Liquids Delivery Hose



FR Tuyau d'aspiration et de transport super élastique pour eau et liquides
ES Manguera Superelástica de Succión y Suministro de Agua y Líquidos
DE Superelastischer Wasser & Flüssigkeiten Saug- und Förderschlauch
RU Суперэластичный напорно-всасывающий шланг для воды и других жидкостей

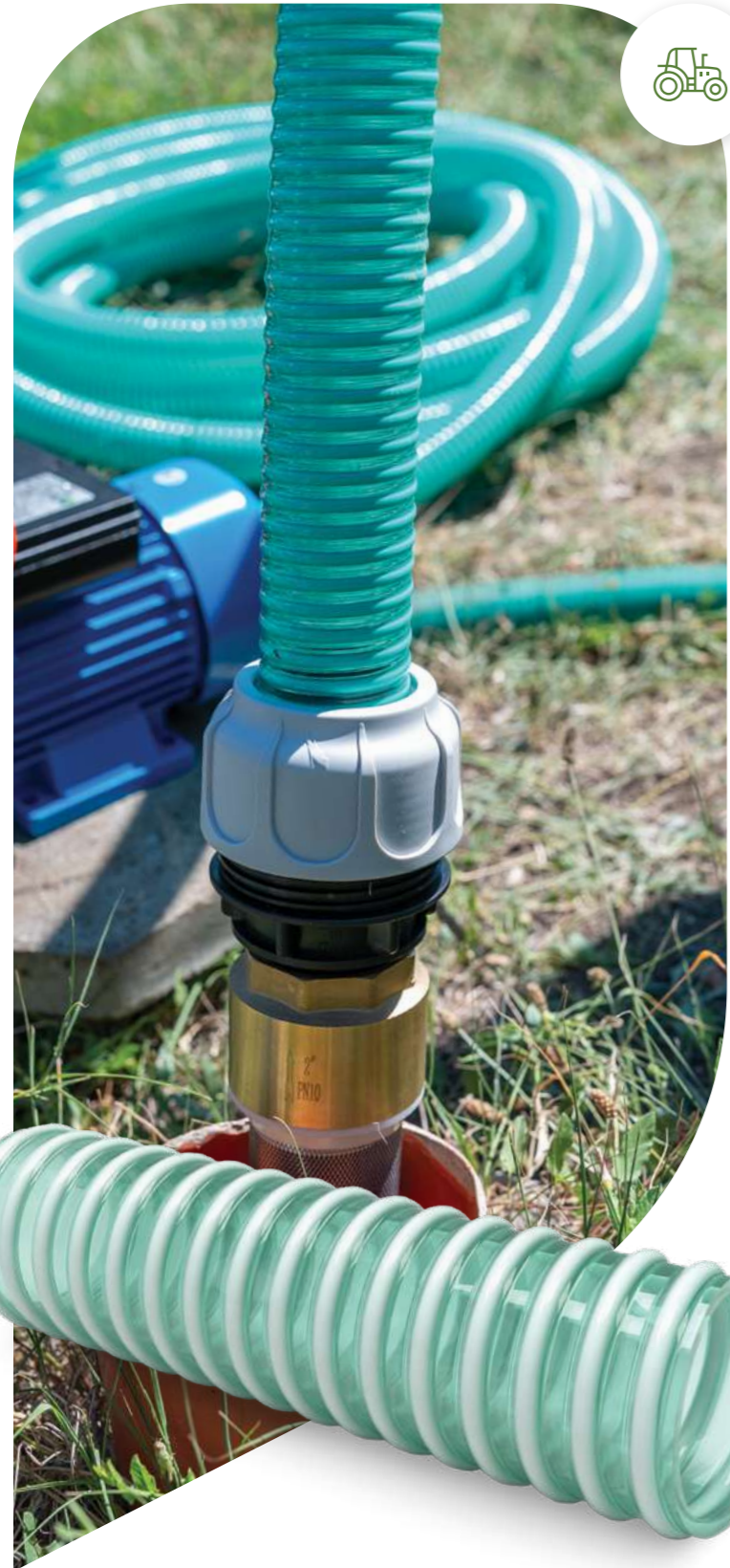

-20°C | +60°C
TEMPERATURE RANGE

HIGH FLEXIBILITY

LOW TEMPERATURE RESISTANCE

EN This hose can be used for suction and delivery of water and other liquids in Agriculture or Construction in low temperature conditions.

FR Ce tuyau peut être utilisé comme un tuyau d'aspiration et de transport pour eau et d'autres liquides dans l'agriculture et la construction dans des conditions de basse température.

ES Esta manguera se puede utilizar para la succión y la entrega de agua y otros líquidos en la agricultura o la construcción en condiciones de baja temperatura.

DE Dieser Schlauch kann zum Ansaugen und Fördern von Wasser und anderen Flüssigkeiten in der Landwirtschaft oder im Bauwesen verwendet werden bei niedrigen Temperaturen.

RU Этот шланг можно использовать для всасывания и транспортировки воды и других жидкостей в сельском хозяйстве и строительстве в при низких температурах.

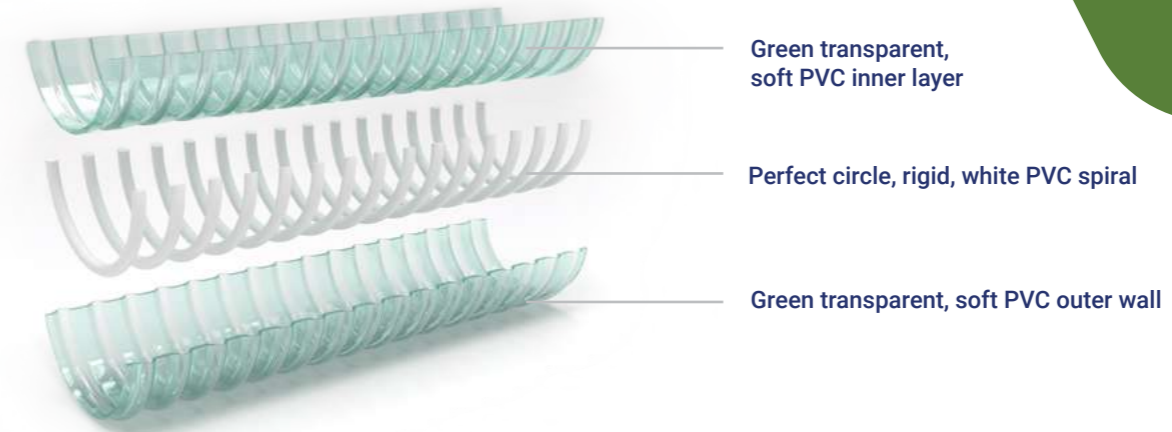

code	inch	mm	gr/m	bar	mbar	mm	m
F008S013	1 1/2	13	115	8	600	39	25/30/50
F008S016	5/8	16	145	7	600	48	25/30/50
F008S019	3/4	19	185	6	600	57	25/30/50
F008S020		20	195	6	600	60	25/30/50
F008S025	1	25	230	6	600	75	25/30/50
F008S030		30	280	5	600	90	25/30/50
F008S032	1 1/4	32	290	5	600	96	25/30/50
F008S035		35	440	5	600	105	25/30/50
F008S038	1 1/2	38	440	5	600	114	25/30/50
F008S040		40	520	4	600	120	25/30/50
F008S045	1 3/4	45	570	4	600	135	25/30/50
F008S051	2	51	690	4	600	153	25/30/50
F008S055		55	740	4	600	165	25/30/50
F008S060		60	800	3,5	600	180	25/30/50
F008S063	2 1/2	63	890	3,5	600	189	25/30/50
F008S070	2 3/4	70	1020	3,5	600	221	25/30/50
F008S076	3	76	1120	3	600	229	25/30/50
F008S080		80	1345	3	600	259	25/30/50
F008S090	3 1/2	90	1500	2	600	281	25
F008S102	4	102	1700	2	600	322	25

* Working and bursting pressure valid at 20°C / Pression de fonctionnement et limite, à 20 ° C / Presión de trabajo y estallido válida a 20°C / Betriebsdruck und Berstdruck gültig bei 20°C / Рабочее давление и разрывное давление, при 20°C
 ** Length tolerance +/- 5% / Tolérance de longueur +/- 5% / Tolerancia de longitud +/- 5% / Längentoleranz +/- 5% / Допуск длины +/- 5%
 *** Inner Diameter tolerance +/- 2% / Tolérance de diamètre interne +/- 2% / Tolerancia del diámetro interno +/- 2% / Toleranz des inneren Durchmessers +/- 2% / Допуск внутреннего диаметра +/- 2%

Other colors are available against MOQ
 Autres couleurs et longueurs sont disponibles avec la quantité minimale d'un ordre
 Se ofrecen otros colores y longitudes contra una cantidad mínima de pedido
 Andere Farben sind gegen Mindestbestellmenge erhältlich
 В другом цвете возможен при соблюдении минимальных количеств к заказу



011N Water & Liquids Suction & Delivery Hose

FR Tuyau d'aspiration et de transport pour eau et liquides
ES Manguera de Succión y Suministro de Agua y Líquidos
DE Wasser & Flüssigkeiten Saug- und Förderschlauch
RU Напорно-всасывающий шланг для воды и и других жидкостей



-10°C | +60°C
TEMPERATURE RANGE

EN This hose can be used for suction and delivery of water and other liquids or solid materials in Agriculture or Construction.

FR Ce tuyau peut être utilisé comme un tuyau d'aspiration et de transport pour eau et d'autres liquides dans l'agriculture et la construction.

ES Esta manguera se puede utilizar para la succión y la entrega de agua y otros líquidos en la agricultura o la construcción.

DE Dieser Schlauch kann zum Ansaugen und Fördern von Wasser und anderen Flüssigkeiten in der Landwirtschaft oder im Bauwesen verwendet werden.

RU Этот шланг можно использовать для всасывания и транспортировки воды и других жидкостей в сельском хозяйстве и строительстве.

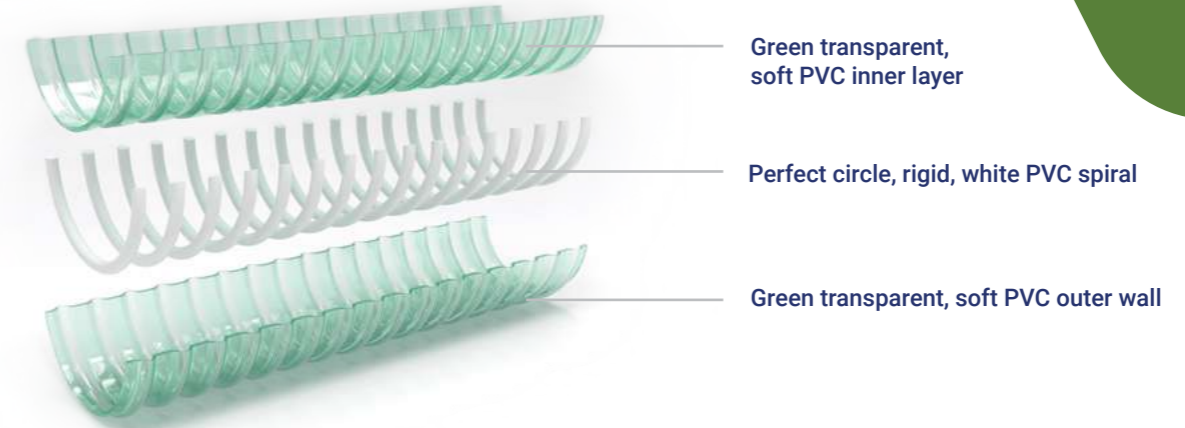

code	inch	mm	gr/m	bar	mbar	mm	m
F011N013	1/2	13	160	10	750	58	25/30/50
F011N016	5/8	16	180	9	750	72	25/30/50
F011N019	3/4	19	270	8	750	85	25/30/50
F011N020		20	280	8	750	90	25/30/50
F011N025	1	25	300	8	750	112	25/30/50
F011N030		30	380	7	750	135	25/30/50
F011N032	1 1/4	32	400	7	750	144	25/30/50
F011N035		35	470	7	750	157	25/30/50
F011N038	1 1/2	38	500	7	750	171	25/30/50
F011N040		40	540	6	750	180	25/30/50
F011N045	1 3/4	45	630	5,5	750	202	25/30/50
F011N051	2	51	765	5,5	750	225	25/30/50
F011N055		55	830	5	750	247	25/30/50
F011N060		60	900	5	750	270	25/30/50
F011N063	2 1/2	63	990	5	750	283	25/30/50
F011N070	2 3/4	70	1080	4	750	315	25/30/50
F011N076	3	76	1260	4	750	337	25/30/50
F011N080		80	1440	4	750	360	25/30/50
F011N090	3 1/2	90	1620	4	750	405	25
F011N102	4	102	1980	4	750	459	25
F011N110	4 1/2	110	2250	3	750	495	25
F011N120		120	2520	3	700	540	25
F011N127	5	127	2880	3	700	562	25
F011N152	6	152	3870	2	700	675	25

* Working and bursting pressure valid at 20°C / Pression de fonctionnement et limite, à 20 ° C / Presión de trabajo y estallido válida a 20°C / Betriebsdruck und Berstdruck gültig bei 20°C / Рабочее давление и разрывное давление, при 20°C
 ** Length tolerance +/- 5% / Tolérance de longueur +/- 5% / Tolerancia de longitud +/- 5% / Längentoleranz +/- 5% / Допуск длины +/- 5%
 *** Inner Diameter tolerance +/- 2% / Tolérance de diamètre interne +/- 2% / Tolerancia del diámetro interno +/- 2% / Toleranz des inneren Durchmessers +/- 2% / Допуск внутреннего диаметра +/- 2%



Other colors are available against MOQ
 • Autres couleurs et longueurs sont disponibles avec la quantité minimale d'un ordre
 • Se ofrecen otros colores y longitudes contra una cantidad mínima de pedido
 • Andere Farben sind gegen Mindestbestellmenge erhältlich
 • В другом цвете возможен при соблюдении минимальных количеств к заказу

011S Superelastic Water & Liquids Suction & Delivery Hose

FR Tuyau d'aspiration et de transport super élastique pour eau et liquides
ES Manguera Superelástica de Succión y Suministro de Agua y Líquidos
DE Superelastischer Wasser & Flüssigkeiten Saug- und Förderschlauch
RU Суперэластичный напорно-всасывающий шланг для воды и других жидкостей



-20°C | +60°C TEMPERATURE RANGE
HIGH FLEXIBILITY
LOW TEMPERATURE RESISTANCE

EN This hose can be used for suction and delivery of water and other liquids or solid materials in Agriculture or Construction in low temperatures.

FR Ce tuyau peut être utilisé comme un tuyau d'aspiration et de transport pour eau et d'autres liquides dans l'agriculture et la construction dans des conditions de basse température.

ES Esta manguera se puede utilizar para la succión y la entrega de agua y otros líquidos en la agricultura o la construcción en condiciones de baja temperatura.

DE Dieser Schlauch kann zum Ansaugen und Fördern von Wasser und anderen Flüssigkeiten in der Landwirtschaft oder im Bauwesen verwendet werden bei niedrigen Temperaturen.

RU Этот шланг можно использовать для всасывания и транспортировки воды и других жидкостей в сельском хозяйстве и строительстве в условиях низкой температуры.

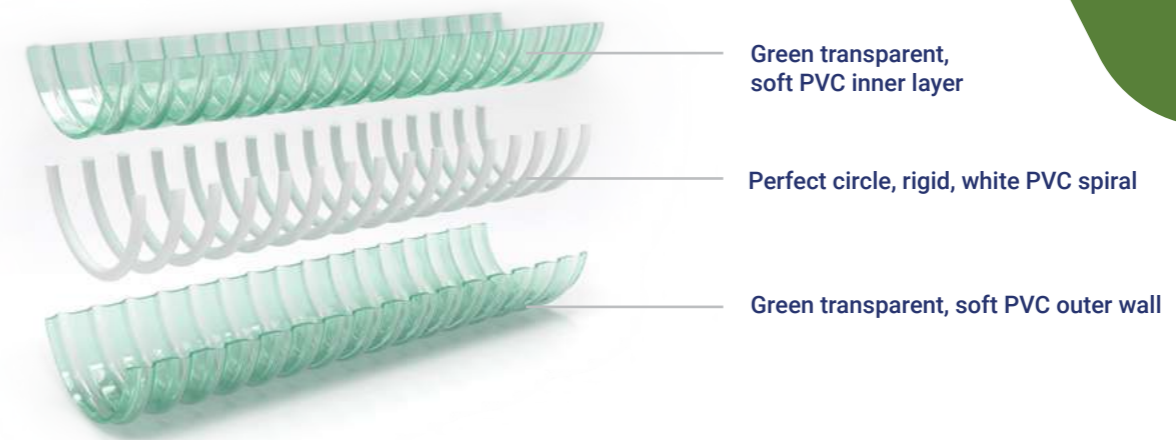

code	inch	mm	gr/m	bar	mbar	mm	m
F011S013	1/2	13	160	8	700	45	25/30/50
F011S016	5/8	16	180	7	700	56	25/30/50
F011S019	3/4	19	270	6	700	66	25/30/50
F011S020		20	280	6	700	70	25/30/50
F011S025	1	25	300	6	700	87	25/30/50
F011S030		30	380	5	700	105	25/30/50
F011S032	1 1/4	32	400	5	700	112	25/30/50
F011S035		35	470	5	700	122	25/30/50
F011S038	1 1/2	38	500	5	700	133	25/30/50
F011S040		40	540	4	700	140	25/30/50
F011S045	1 3/4	45	630	4	700	157	25/30/50
F011S051	2	51	765	4	700	178	25/30/50
F011S055		55	830	3,5	700	192	25/30/50
F011S060		60	900	3,5	700	210	25/30/50
F011S063	2 1/2	63	990	3,5	700	220	25/30/50
F011S070	2 3/4	70	1080	3	700	245	25/30/50
F011S076	3	76	1260	3	700	262	25/30/50
F011S080		80	1440	3	700	280	25/30/50
F011S090	3 1/2	90	1620	3	700	315	25
F011S102	4	102	1980	3	700	357	25
F011S110	4 1/2	110	2250	2	700	440	25
F011S120		120	2520	2	700	480	25
F011S127	5	127	2880	2	700	500	25
F011S152	6	152	3870	2	700	608	25

* Working and bursting pressure valid at 20°C / Pression de fonctionnement et limite, à 20 ° C / Presión de trabajo y estallido válida a 20°C / Betriebsdruck und Berstdruck gültig bei 20°C / Рабочее давление и разрывное давление, при 20°C

** Length tolerance +/- 5% / Tolérance de longueur +/- 5% / Tolerancia de longitud +/- 5% / Längentoleranz +/- 5% / Допуск длины +/- 5%

*** Inner Diameter tolerance +/- 2% / Tolérance de diamètre interne +/- 2% / Tolerancia del diámetro interno +/- 2% / Toleranz des inneren Durchmessers +/- 2% / Допуск внутреннего диаметра +/- 2%

REACH COMPLIANT
RoHS COMPLIANT
1307:2006 CERTIFIED
9001:2015 CERTIFIED

- Other colors are available against MOQ
- Autres couleurs et longueurs sont disponibles avec la quantité minimale d'un ordre
- Se ofrecen otros colores y longitudes contra una cantidad mínima de pedido
- Andere Farben sind gegen Mindestbestellmenge erhältlich
- В другом цвете возможен при соблюдении минимальных количеств к заказу

010N Liquids and Abrasives Suction & Delivery Hose



FR Tuyau d'aspiration et de transport pour liquides et abrasifs
ES Manguera de succión y entrega de líquidos y abrasivos
DE Flüssigkeiten und Schleifmittel Saug- und Druckschlauch
RU Напорно-всасывающий шланг для жидкостей и абразивных материалов

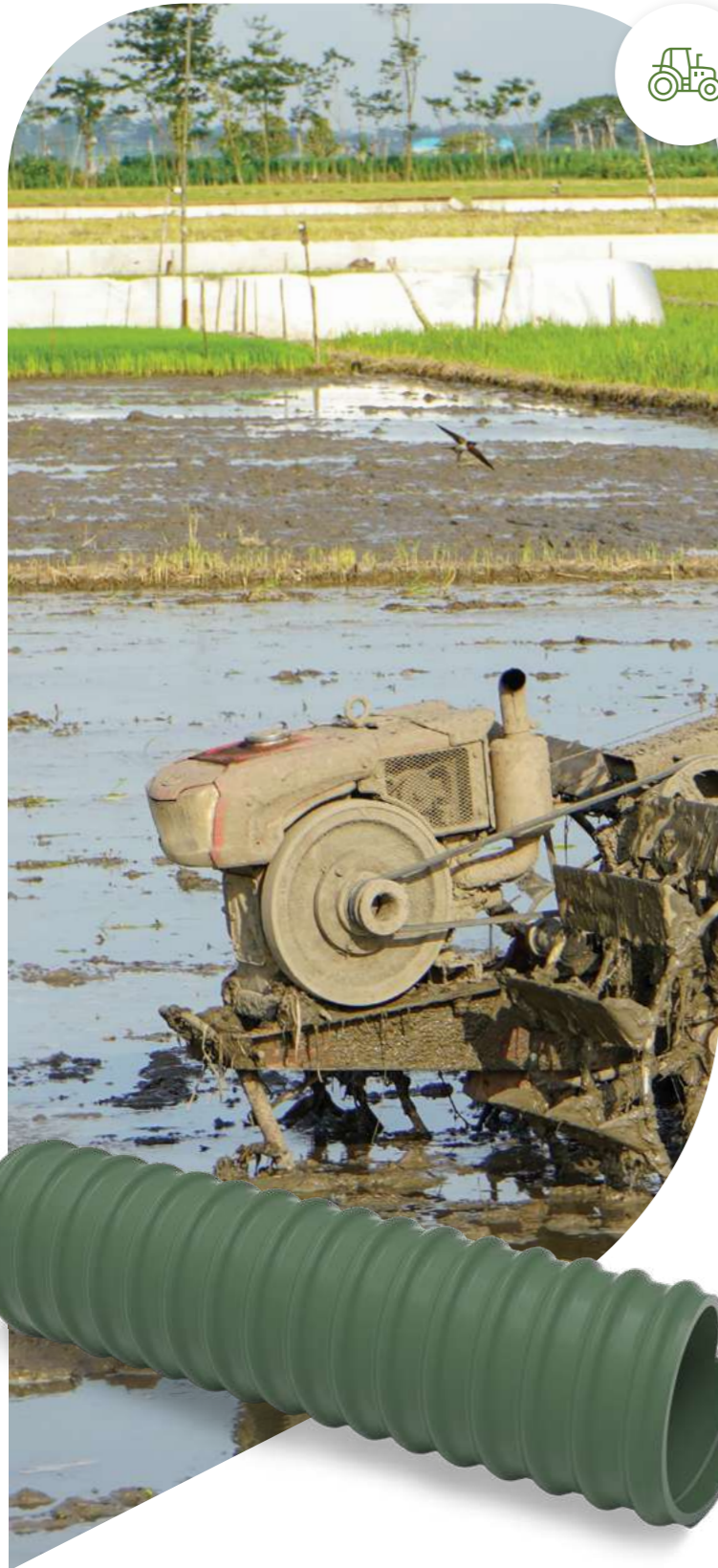

-10°C | +60°C
TEMPERATURE RANGE

SMOOTH INSIDE

EN This hose can be used for suction and delivery of fresh and sea water, sewage, fertilizers, chemical solutions, abrasive solids and slurries etc.

FR Ce tuyau peut être utilisé comme un tuyau d'aspiration et de transport pour eau et d'autres liquides ou matières solides dans l'agriculture et la construction.

ES Esta manguera se puede utilizar para la succión y la entrega de agua y otros líquidos o materiales sólidos en la agricultura o la construcción.

DE Dieser Schlauch kann zum Ansaugen und Fördern von Wasser und anderen Flüssigkeiten oder Feststoffe in der Landwirtschaft oder im Bauwesen verwendet werden.

RU Этот шланг можно использовать для всасывания и транспортировки воды и других жидкостей или твердых материалов в сельском хозяйстве и строительстве.

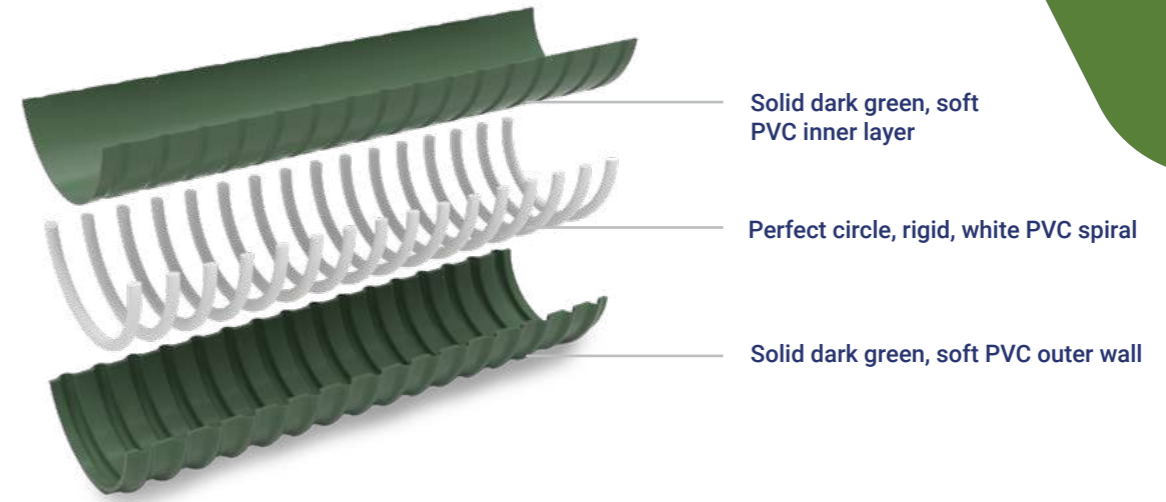

code	inch	mm	gr/m	bar	mbar	mm	m
F010N019	3/4	19	335	8	900	95	25/30/50
F010N020		20	335	7	900	100	25/30/50
F010N025	1	25	400	6	900	125	25/30/50
F010N030		30	535	6	900	150	25/30/50
F010N032	1 1/4	32	580	6	900	160	25/30/50
F010N035		35	610	6	900	175	25/30/50
F010N038	1 1/2	38	680	6	900	190	25/30/50
F010N040		40	710	5	900	200	25/30/50
F010N045	1 3/4	45	815	5	900	225	25/30/50
F010N051	2	51	970	5	900	250	25/30/50
F010N055		55	1065	5	900	275	25/30/50
F010N060		60	1240	5	900	300	25/30/50
F010N063	2 1/2	63	1405	4,5	900	315	25/30/50
F010N070	2 3/4	70	1550	4,5	900	350	25/30/50
F010N076	3	76	1680	4,5	900	375	25/30/50
F010N080		80	1795	4,5	800	400	25/30/50
F010N090	3 1/2	90	2055	4	800	450	25
F010N102	4	102	2600	3	800	500	25
F010N110	4 1/2	110	2910	3	800	550	25
F010N120		120	3200	3	800	600	25
F010N127	5	127	3395	2,5	800	625	25
F010N152	6	152	5000	2,5	800	850	25

* Working and bursting pressure valid at 20°C // Pression de fonctionnement et limite, à 20 ° C / Presión de trabajo y estallido válida a 20°C / Betriebsdruck und Berstdruck gültig bei 20°C / Рабочее давление и разрывное давление, при 20°C
 ** Length tolerance +/- 5% / Tolérance de longueur +/- 5% / Tolerancia de longitud +/- 5% / Längentoleranz +/- 5% / Допуск длины +/- 5%
 *** Inner Diameter tolerance +/- 2% / Tolérance de diamètre interne +/- 2% / Tolerancia del diámetro interno +/- 2% / Toleranz des inneren Durchmessers +/- 2% / Допуск внутреннего диаметра +/- 2%







Other colors are available against MOQ
 • Autres couleurs et longueurs sont disponibles avec la quantité minimale d'un ordre
 • Se ofrecen otros colores y longitudes contra una cantidad mínima de pedido
 • Andere Farben sind gegen Mindestbestellmenge erhältlich
 • В другом цвете возможен при соблюдении минимальных количеств к заказу

010S Superelastic Liquids and Abrasives Suction & Delivery Hose

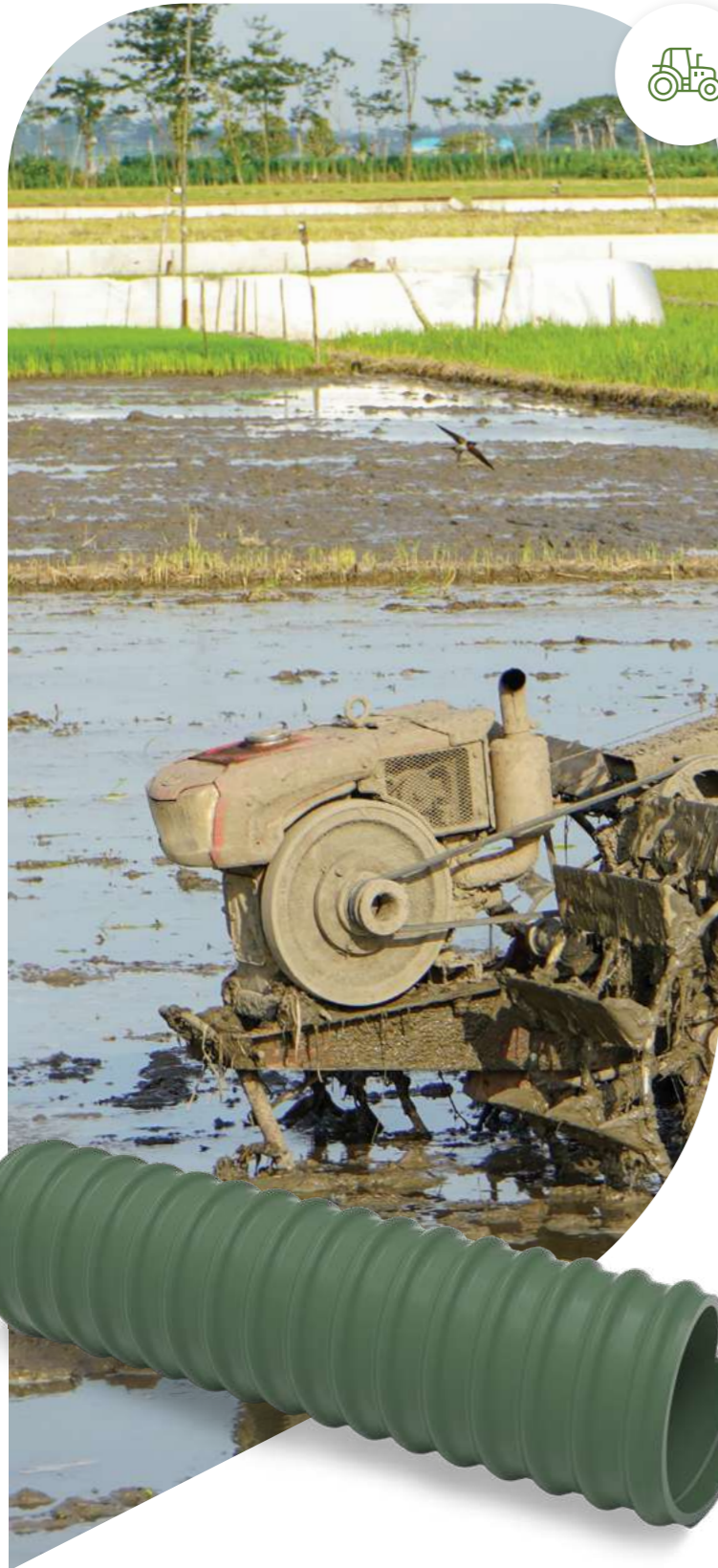

FR Tuyau d'aspiration et de transport pour liquides et abrasifs. Superélastique.
ES Manguera de succión y entrega de líquidos y abrasivos. Superelástico.
DE Flüssigkeiten und Schleifmittel Saug- und Druckschlauch. Superelastisch.
RU Напорно-всасывающий шланг для жидкостей и абразивных материалов. Сверхэластичный.



- 
-20°C | +60°C
TEMPERATURE RANGE
- 
HIGH FLEXIBILITY
- 
LOW TEMPERATURE RESISTANCE
- 
SMOOTH INSIDE

EN This hose can be used for suction and delivery of fresh and sea water, sewage, fertilizers, chemical solutions, abrasive solids and slurries etc.

FR Ce tuyau peut être utilisé comme un tuyau d'aspiration et de transport pour eau et d'autres liquides ou matières solides dans l'agriculture et la construction.

ES Esta manguera se puede utilizar para la succión y la entrega de agua y otros líquidos o materiales sólidos en la agricultura o la construcción.

DE Dieser Schlauch kann zum Ansaugen und Fördern von Wasser und anderen Flüssigkeiten oder Feststoffe in der Landwirtschaft oder im Bauwesen verwendet werden.

RU Этот шланг можно использовать для всасывания и транспортировки воды и других жидкостей или твердых материалов в сельском хозяйстве и строительстве.

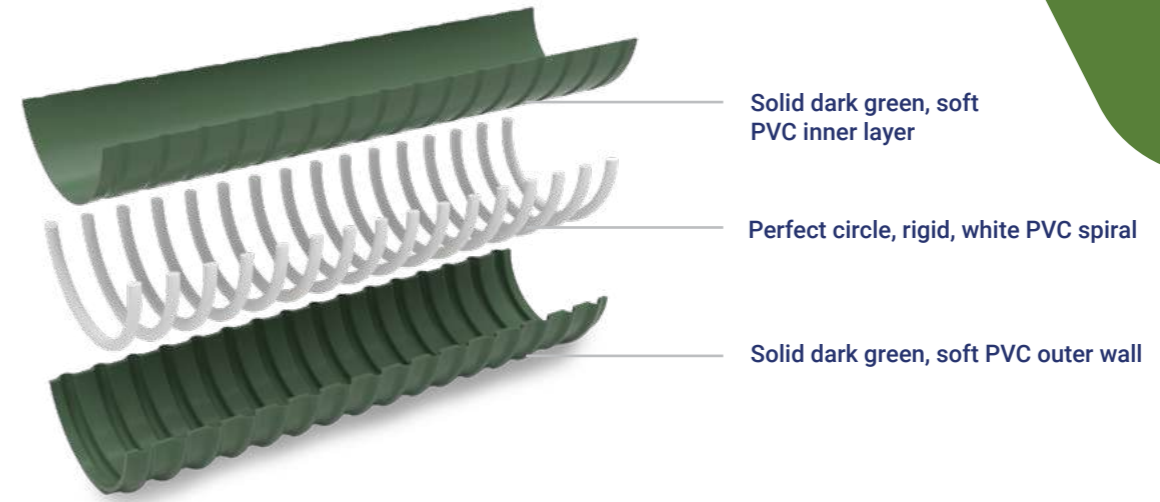

code	inch	mm	gr/m	bar	mbar	mm	m
F010S019	3/4	19	335	7	850	80	25/30/50
F010S020		20	335	7	850	80	25/30/50
F010S025	1	25	400	7	850	100	25/30/50
F010S030		30	535	6	850	120	25/30/50
F010S032	1 1/4	32	580	6	850	128	25/30/50
F010S035		35	610	5	850	140	25/30/50
F010S038	1 1/2	38	680	5	850	152	25/30/50
F010S040		40	710	5	850	160	25/30/50
F010S045	1 3/4	45	815	5	850	180	25/30/50
F010S051	2	51	970	5	850	200	25/30/50
F010S055		55	1065	4.5	850	220	25/30/50
F010S060		60	1240	4.5	850	240	25/30/50
F010S063	2 1/2	63	1405	4.5	750	252	25/30/50
F010S070		70	1550	4	750	280	25/30/50
F010S076	3	76	1680	4	750	300	25/30/50
F010S080		80	1795	4	750	320	25/30/50
F010S090	3 1/2	90	2055	4	750	360	25/30
F010S102	4	102	2600	3	750	400	25/30
F010S110	4 1/2	110	2910	3	750	440	25
F010S120		120	3200	3	750	470	25
F010S127	5	127	3395	3	750	500	25
F010S152	6	152	5000	2.5	750	600	25

* Working and bursting pressure valid at 20°C // Pression de fonctionnement et limite, à 20 ° C / Presión de trabajo y estallido válida a 20°C / Betriebsdruck und Berstdruck gültig bei 20°C / Рабочее давление и разрывное давление, при 20°C

** Length tolerance +/- 5% / Tolérance de longueur +/- 5% / Tolerancia de longitud +/- 5% / Längentoleranz +/- 5% / Допуск длины +/- 5%

*** Inner Diameter tolerance +/- 2% / Tolérance de diamètre interne +/- 2% / Tolerancia del diámetro interno +/- 2% / Toleranz des inneren Durchmessers +/- 2% / Допуск внутреннего диаметра +/- 2%

Other colors are available against MOQ
 Autres couleurs et longueurs sont disponibles avec la quantité minimale d'un ordre
 Se ofrecen otros colores y longitudes contra una cantidad mínima de pedido
 Andere Farben sind gegen Mindestbestellmenge erhältlich
 В другом цвете возможен при соблюдении минимальных количеств к заказу



006Z Flexible Agro Hose

FR Tuyau Agro Flexible
 ES Manguera agrícola flexible
 DE Flexibler Agroschlauch
 RU Гибкий агрошланг



-20°C | +60°C
TEMPERATURE RANGE
HIGH FLEXIBILITY
LOW TEMPERATURE RESISTANCE
SMOOTH INSIDE

EN The Flexible Agro Hose is mainly used in agriculture, especially for slurry spreading machines and seeders. PVC hose with excellent flexibility at low temperatures and smooth surface.

FR Le Flexible Agro Hose est principalement utilisé dans l'agriculture, notamment pour l'épandage de lisier machines et semoirs. Tuyau en PVC avec une excellente flexibilité à basse température et une surface lisse.

ES La manguera flexible Agro se utiliza principalmente en agricultura, especialmente para esparcir purines máquinas y sembradoras. Manguera de PVC con excelente flexibilidad a bajas temperaturas y superficie lisa.

DE Der flexible Agroschlauch wird hauptsächlich in verwendet Landwirtschaft, insbesondere zum Ausbringen von Gülle Maschinen und Sämaschinen. PVC-Schlauch mit ausgezeichneter Flexibilität bei niedrigen Temperaturen und glatter Oberfläche.

RU Гибкий агрошланг в основном используется в сельское хозяйство, особенно для внесения навозной жижи машины и сеялки. Шланг из ПВХ с отличной гибкостью при низких температурах и гладкой поверхностью.

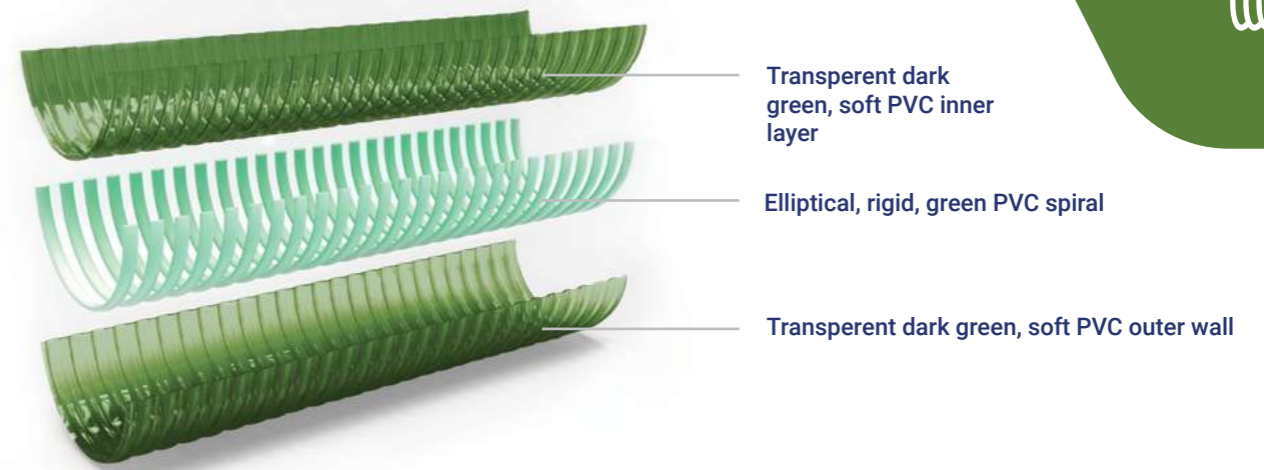

code	inch	mm	gr/m	bar	mbar	mm	m
F006Z040		40	540	4	600	120	25/30/50
F006Z041		41	542	4	600	120	25/30/50
F006Z045		45	570	4	600	120	25/30/50
F006Z050		50	765	4	600	120	25/30/50
F006Z051		51	765	4	600	120	25/30/50

* **Working and bursting pressure valid at 20°C** / / Pression de fonctionnement et limite, à 20 ° C / Presión de trabajo y estallido válida a 20°C / Betriebsdruck und Berstdruck gültig bei 20°C / Рабочее давление и разрывное давление, при 20°C

** **Length tolerance +/- 5%** / Tolérance de longueur +/- 5% / Tolerancia de longitud +/- 5% / Längentoleranz +/- 5% / Допуск длины +/- 5%

*** **Inner Diameter tolerance +/- 2%** / Tolérance de diamètre interne +/- 2% / Tolerancia del diámetro interno +/- 2% / Toleranz des inneren Durchmessers +/- 2% / Допуск внутреннего диаметра +/- 2%



REACH COMPLIANT
RoHS COMPLIANT
ISO 1307:2006 CERTIFIED
ISO 9001:2015 CERTIFIED

302N PVC Braided Garden Hose

FR Tuyau d'arrosage tressé en PVC
 ES Manguera de jardín trenzada de PVC
 DE PVC-Gartenschlauch mit Geflecht
 RU Оплетенный поливочный шланг ПВХ



 -10°C | +60°C
 TEMPERATURE RANGE

EN This hose can be used for water delivery in gardening, horticulture, floriculture, construction sites etc.

FR Ce tuyau peut être utilisé pour le transport d'eau dans l'horticulture, la culture des plantes, la floriculture, les chantiers de construction et autres.

ES Esta manguera se puede usar para la entrega de agua en jardinería, horticultura, floricultura, obras de construcción, etc.

DE Dieser Schlauch kann für die Wasserzufuhr in Gärtnerei, Gartenbau, Blumenzucht, Baustellen usw. verwendet werden.

RU Этот шланг можно использовать для транспортировки воды в садоводстве, растениеводстве, цветоводстве, на строительных объектах и прочее.

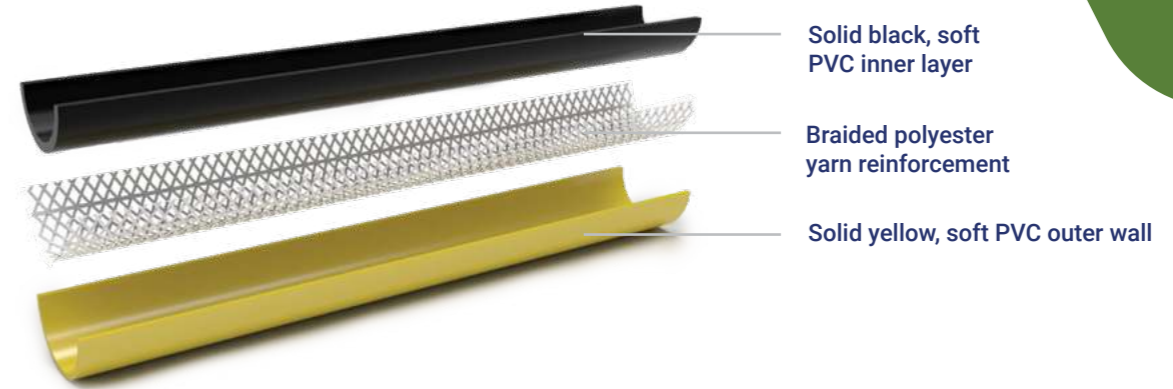

code	inch	mm	mm	gr/m	bar	bar	m
V302N010	3/8	10	16,3	150	9	27	25/50/100
V302N013	1/2	13	17,2	160	9	27	25/50/100
V302N016	5/8	16	20,4	195	8	24	25/50/100
V302N019	3/4	19	25	260	8	24	25/50/100
V302N025	1	25	30,4	320	6	18	25/50/100

* **Working and bursting pressure valid at 20°C** // Pression de fonctionnement et limite, à 20 ° C / Presión de trabajo y estallido válida a 20°C / Betriebsdruck und Berstdruck gültig bei 20°C / Рабочее давление и разрывное давление, при 20°C
 ** **Length tolerance +/- 5%** / Tolérance de longueur +/- 5% / Tolerancia de longitud +/- 5% / Längentoleranz +/- 5% / Допуск длины +/- 5%
 *** **Inner Diameter tolerance +/- 2%** / Tolérance de diamètre interne +/- 2% / Tolerancia del diámetro interno +/- 2% / Toleranz des inneren Durchmessers +/- 2% / Допуск внутреннего диаметра +/- 2%

 Other colors are available against MOQ
 • Autres couleurs et longueurs sont disponibles avec la quantité minimale d'un ordre
 • Se ofrecen otros colores y longitudes contra una cantidad mínima de pedido
 • Andere Farben sind gegen Mindestbestellmenge erhältlich
 • В другом цвете возможен при соблюдении минимальных количеств к заказу



204N Double Layer PVC Layflat Hose

FR Tuyau plat en PVC à double couche
 ES Manguera Layflat de PVC de doble capa
 DE Doppelschichtiger PVC Flachschauch
 RU Двухслойный напорный плоский шланг ПВХ



- 10°C | +60°C**
 TEMPERATURE RANGE
- UV RESISTANT**
- EASY TO STORE AND INSTALL**

EN This hose can be used for:
 1. Light duty water discharge hose in agriculture, civil engineering construction sites, on tank trucks, boats, ships.
 2. Water delivery or supply of liquid fertilizers to surface irrigation systems and sprinklers.

FR Ce tuyau peut être utilisé pour:
 1. Tuyau d'échappement pour eau dans des conditions légères dans l'agriculture, les chantiers de construction civils, les citernes de camions, bateaux, navires.
 2. Transport d'eau ou d'engrais liquides vers les systèmes d'irrigation de surface et les systèmes de pulvérisation.

ES Esta manguera se puede usar para:
 1. Manguera de descarga de agua en aplicaciones de servicio ligero en agricultura, sitios de construcción de ingeniería civil, en camiones cisterna, barcos, naves.
 2. Suministro de agua o suministro de fertilizantes líquidos a los sistemas de riego de superficie y rociadores.

DE Dieser Schlauch kann verwendet werden als:
 1. Leichter Wasserablaufschlauch in der Landwirtschaft, auf Tiefbau-Baustellen, auf Tankwagen, Booten, Schiffen.
 2. Wasserversorgung oder Lieferung von Flüssigdüngern an Oberflächenbewässerungs-Systeme und Sprinkleranlagen.

RU Области применения шланга:
 1. При легком режиме сливной шланг работы в сельском хозяйстве, на объектах гражданского строительства, для автоцистерн, лодок, судов.
 2. Подача воды или жидкой подкормки на поверхностные оросительные установки и разбрызгиватели.

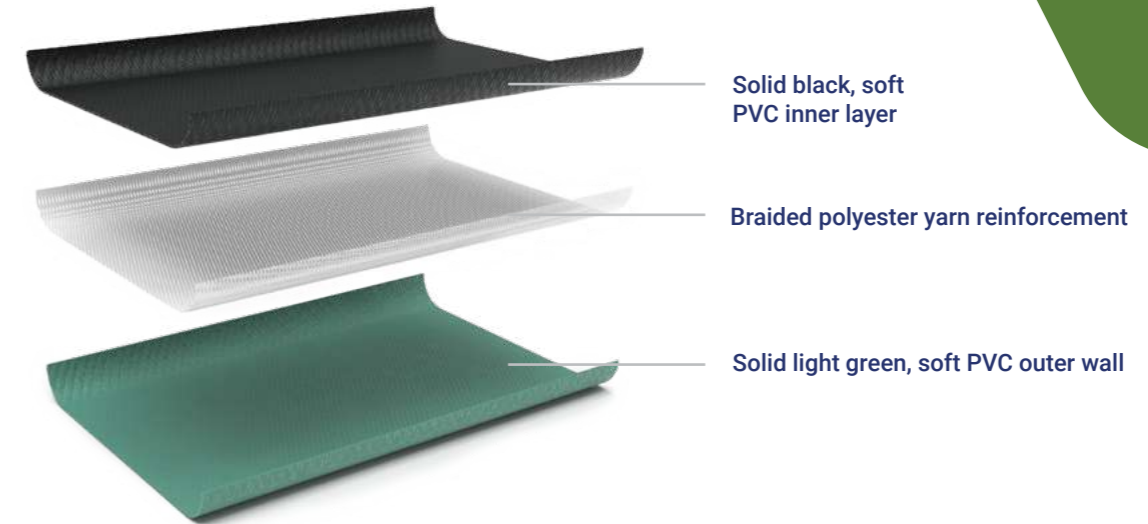

code	inch	mm	gr/m	bar	bar	m ²
L204N025	1	25	170	4	14	50/100
L204N032	1 1/4	32	200	4	14	50/100
L204N038	1 1/2	38	240	4	13	50/100
L204N040		40	250	4	12	50/100
L204N045	1 3/4	45	260	4	12	50/100
L204N051	2	51	270	4	11	50/100
L204N055		55	320	4	11	50/100
L204N060		60	340	4	11	50/100
L204N063	2 1/2	63	360	4	11	50/100
L204N070		70	400	3	8	50/100
L204N076	3	76	420	3	8	50/100
L204N080		80	450	3	8	50/100
L204N090	3 1/2	90	530	3	8	50/100
L204N102	4	102	620	2	7	50/100
L204N127	5	127	850	1,5	5	50
L204N153	6	153	1100	1,5	5	50

* **Working and bursting pressure valid at 20°C** // Pression de fonctionnement et limite, à 20 ° C / Presión de trabajo y estallido válida a 20°C / Betriebsdruck und Berstdruck gültig bei 20°C / Рабочее давление и разрывное давление, при 20°C
 ** **Length tolerance +/- 5%** / Tolérance de longueur +/- 5% / Tolerancia de longitud +/- 5% / Längentoleranz +/- 5% / Допуск длины +/- 5%
 *** **Inner Diameter tolerance +/- 2%** / Tolérance de diamètre interne +/- 2% / Tolerancia del diámetro interno +/- 2% / Toleranz des inneren Durchmessers +/- 2% / Допуск внутреннего диаметра +/- 2%

Other colors are available against MOQ
 • Autres couleurs et longueurs sont disponibles avec la quantité minimale d'un ordre
 • Se ofrecen otros colores y longitudes contra una cantidad mínima de pedido
 • Andere Farben sind gegen Mindestbestellmenge erhältlich
 • В другом цвете возможен при соблюдении минимальных количеств к заказу



206N Double Layer PVC Layflat Hose

FR Tuyau plat en PVC à double couche
 ES Manguera Layflat de PVC de doble capa
 DE Doppelschichtiger PVC Flachschauch
 RU Двухслойный напорный плоский шланг ПВХ



- 10°C | +60°C**
 TEMPERATURE RANGE
- UV RESISTANT**
- EASY TO STORE AND INSTALL**

EN This hose can be used for:
 1. Light duty water discharge hose in agriculture, civil engineering, construction sites, on tank trucks, boats, ships.
 2. Water delivery or supply of liquid fertilizers to surface irrigation systems and sprinklers.

FR Ce tuyau peut être utilisé pour:
 1. Tuyau d'échappement pour eau dans des conditions légères dans l'agriculture, les chantiers de construction civils, les citernes de camions, bateaux, navires.
 2. Transport d'eau ou d'engrais liquides vers les systèmes d'irrigation de surface et les systèmes de pulvérisation.

ES Esta manguera se puede usar para:
 1. Manguera de descarga de agua en aplicaciones de servicio ligero en agricultura, sitios de construcción de ingeniería civil, en camiones cisterna, barcos, naves.
 2. Suministro de agua o suministro de fertilizantes líquidos a los sistemas de riego de superficie y rociadores.

DE Dieser Schlauch kann verwendet werden als:
 1. Leichter Wasserablaufschlauch in der Landwirtschaft, auf Tiefbau- Baustellen, auf Tankwagen, Booten, Schiffen.
 2. Wasserversorgung oder Lieferung von Flüssigdüngern an Oberflächenbewässerungs-Systeme und Sprinkleranlagen.

RU Области применения шланга:
 1. При легком режиме сливной шланг работы в сельском хозяйстве, на объектах гражданского строительства, для автоцистерн, лодок, судов.
 2. Подача воды или жидкой подкормки на наземные оросительные установки и разбрызгиватели.

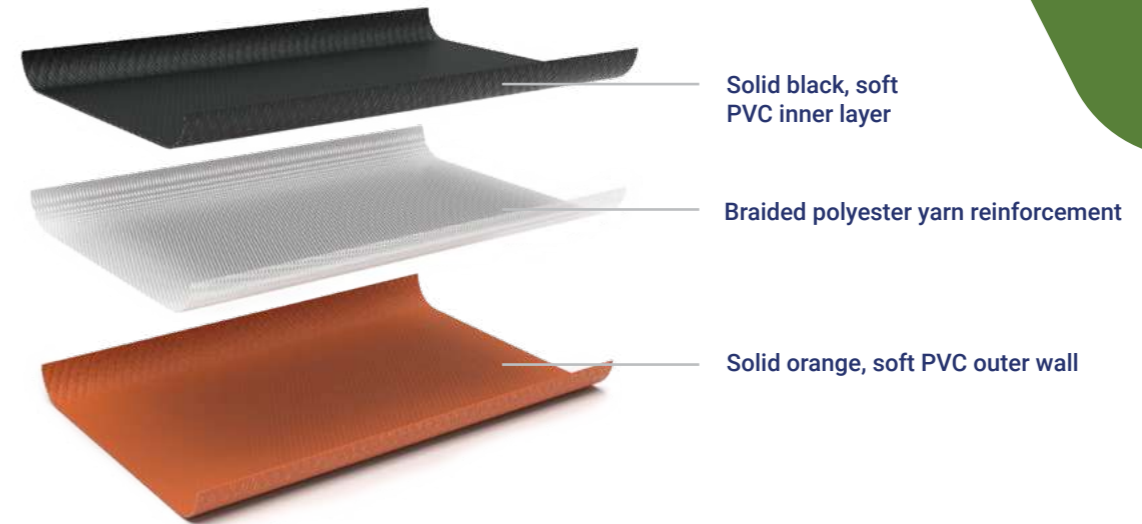

code	inch	mm	gr/m	bar	bar	m
L206N025	1	25	200	6	14	50/100
L206N032	1 1/4	32	220	6	14	50/100
L206N035		35	240	6	14	50/100
L206N038	1 1/2	38	260	6	14	50/100
L206N040		40	280	5	14	50/100
L206N045	1 3/4	45	310	5	14	50/100
L206N051	2	51	360	5	14	50/100
L206N055		55	400	5	14	50/100
L206N060		60	430	5	14	50/100
L206N063	2 1/2	63	440	4,5	13	50/100
L206N070		70	470	4,5	12	50/100
L206N076	3	76	520	4,5	12	50/100
L206N080		80	560	4	12	50/100
L206N090	3 1/2	90	640	4	12	50/100
L206N102	4	102	760	3,5	11	50/100
L206N127	5	127	1020	3	8	50
L206N153	6	153	1280	3	8	50
L206N203	8	203	2000	2,5	7	50

* Working and bursting pressure valid at 20°C // Pression de fonctionnement et limite, à 20 ° C / Presión de trabajo y estallido válida a 20°C / Betriebsdruck und Berstdruck gültig bei 20°C / Рабочее давление и разрывное давление, при 20°C
 ** Length tolerance +/- 5% / Tolérance de longueur +/- 5% / Tolerancia de longitud +/- 5% / Längentoleranz +/- 5% / Допуск длины +/- 5%
 *** Inner Diameter tolerance +/- 2% / Tolérance de diamètre interne +/- 2% / Tolerancia del diámetro interno +/- 2% / Toleranz des inneren Durchmessers +/- 2% / Допуск внутреннего диаметра +/- 2%

Other colors are available against MOQ
 • Autres couleurs et longueurs sont disponibles avec la quantité minimale d'un ordre
 • Se ofrecen otros colores y longitudes contra una cantidad mínima de pedido
 • Andere Farben sind gegen Mindestbestellmenge erhältlich
 • В другом цвете возможен при соблюдении минимальных количеств к заказу



208N Double Layer PVC Layflat Hose



FR Tuyau plat en PVC à double couche
 ES Manguera Layflat de PVC de doble capa
 DE Doppelschichtiger PVC Flachschauch
 RU Двухслойный напорный плоский шланг ПВХ



- 10°C | +60°C**
TEMPERATURE RANGE
- UV RESISTANT**
- HIGH PRESSURE RESISTANCE**
- EASY TO STORE AND INSTALL**

EN This hose can be used for:
 1. Water discharge in dewatering projects and industry
 2. Water delivery or supply of liquid fertilizers and other agricultural chemicals
 3. Surface irrigation systems and sprinklers

FR Ce tuyau peut être utilisé pour:
 1. Évacuation d'eau dans les projets et les installations de drainage.
 2. Transport d'eau ou approvisionnement en engrais liquides et en autres produits chimiques agricoles
 3. Systèmes d'irrigation de surface et de pulvérisation

ES Esta manguera se puede usar para:
 1. Descarga de agua en proyectos de deshidratación e industria.
 2. Suministro de agua o suministro de fertilizantes líquidos y otros productos químicos agrícolas
 3. Sistemas de irrigación de superficie y rociadores.

DE Dieser Schlauch kann verwendet werden als:
 1. Wasserableitung in Entwässerungsprojekten und in der Industrie
 2. Wasserversorgung oder Lieferung von Flüssigdüngern und anderen Agrarchemikalien
 3. Oberflächenbewässerungssysteme und Sprinkleranlagen

RU Области применения шланга:
 1. Водоспуск на объектах водоотлива и промышленности
 2. Транспортировка воды или подача жидких удобрений и других сельскохозяйственных химикатов
 3. Наземные системы орошения и разбрызгивания

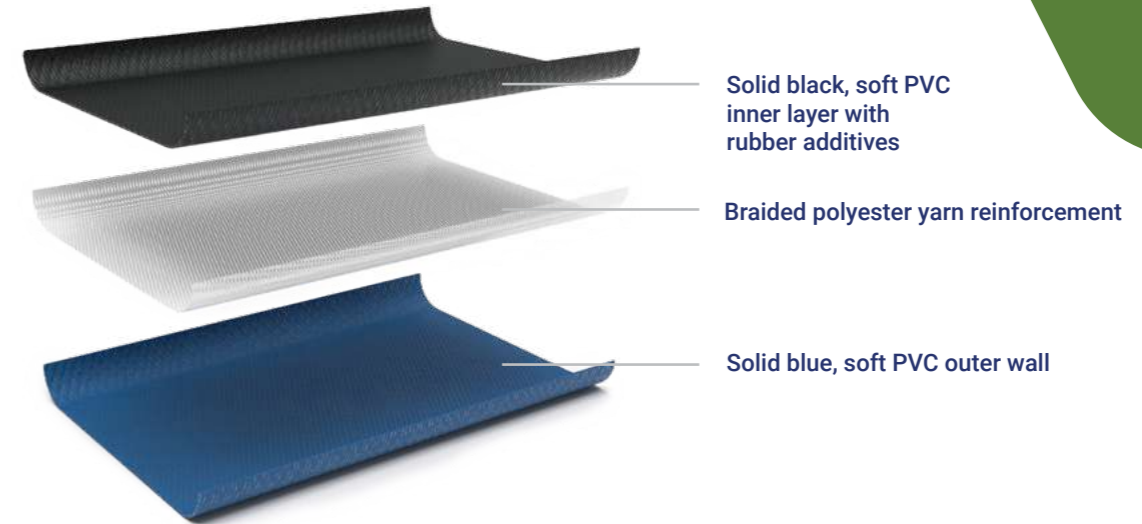

code	inch	mm	gr/m	bar	bar	m
L208N025	1	25	200	8	24	50/100
L208N030		30	220	8	24	50/100
L208N032	1 1/4	32	230	8	24	50/100
L208N035		35	250	8	24	50/100
L208N038	1 1/2	38	270	8	24	50/100
L208N040		40	290	8	24	50/100
L208N045	1 3/4	45	320	8	24	50/100
L208N051	2	51	360	8	24	50/100
L208N055		55	420	8	24	50/100
L208N060		60	435	8	24	50/100
L208N063	2 1/2	63	500	8	24	50/100
L208N070		70	570	8	24	50/100
L208N076	3	76	600	8	24	50/100
L208N080		80	660	8	24	50/100
L208N090	3 1/2	90	760	8	24	50/100
L208N102	4	102	850	8	24	50/100
L208N127	5	127	1250	5,5	17	50
L208N153	6	153	1580	5,5	17	50
L208N203	8	203	2200	2,5	8	50

* **Working and bursting pressure valid at 20°C** // Pression de fonctionnement et limite, à 20 ° C / Presión de trabajo y estallido válida a 20°C / Betriebsdruck und Berstdruck gültig bei 20°C / Рабочее давление и разрывное давление, при 20°C
 ** **Length tolerance +/- 5%** / Tolérance de longueur +/- 5% / Tolerancia de longitud +/- 5% / Längentoleranz +/- 5% / Допуск длины +/- 5%
 *** **Inner Diameter tolerance +/- 2%** / Tolérance de diamètre interne +/- 2% / Tolerancia del diámetro interno +/- 2% / Toleranz des inneren Durchmessers +/- 2% / Допуск внутреннего диаметра +/- 2%

• Other colors are available against MOQ
 • Autres couleurs et longueurs sont disponibles avec la quantité minimale d'un ordre
 • Se ofrecen otros colores y longitudes contra una cantidad mínima de pedido
 • Andere Farben sind gegen Mindestbestellmenge erhältlich
 • В другом цвете возможен при соблюдении минимальных количеств к заказу





Ventilation

Ventilation | Ventilación
Belüftung | Вентиляция

130N Cable Protection Hose

FR Tuyau de protection de câble
 ES Manguera de protección de cables
 DE Kabelschutzschlauch
 RU Защитный шланг для кабеля



 **-10°C | +60°C**
TEMPERATURE RANGE

 **HIGH FLEXIBILITY**

EN This hose can be used for:
 1. Sheathing and protection of cables used in industry, electronics, agriculture and construction.





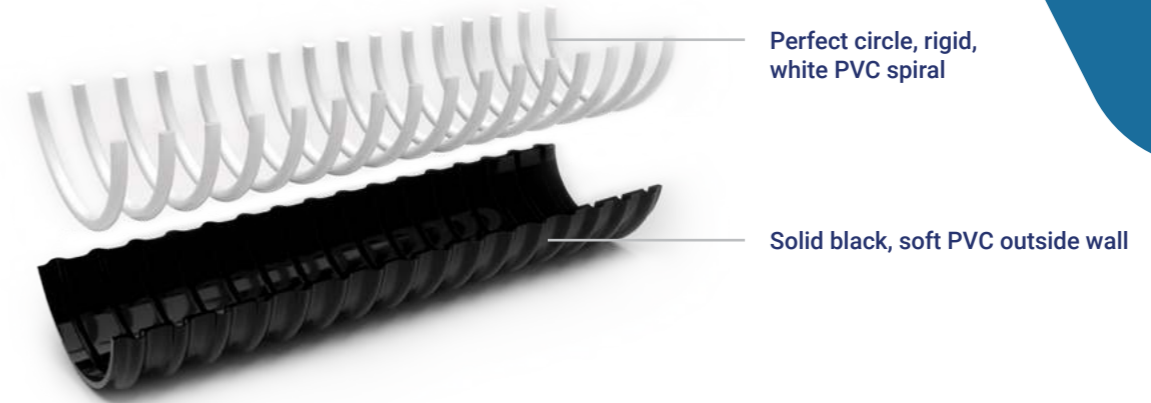

FR Ce tuyau peut être utilisé pour:
 1. En tant que revêtement et protection des câbles utilisés dans l'industrie, l'électronique, l'agriculture et la construction.

ES Esta manguera se puede usar para:
 1. Revestimiento y protección de cables utilizados en la industria, electrónica, agricultura y construcción.

DE Dieser Schlauch kann verwendet werden als:
 1. Ummantelung und Schutz von Kabeln für Industrie, Elektronik, Landwirtschaft und Bauwesen

RU Области применения шланга:
 1. Как покрытие и средство защиты кабелей, используемых в промышленности, электронике, сельском хозяйстве и строительстве



						
code	inch	mm	gr/m	mbar	mm	m
F130N010		10	65	400	20	25/30/50
F130N013	1/2	13	75	400	26	25/30/50
F130N016	5/8	16	100	400	32	25/30/50
F130N018		18	115	400	36	25/30/50
F130N019	3/4	19	115	400	38	25/30/50
F130N020		20	125	400	40	25/30/50
F130N025	1	25	165	400	50	25/30/50
F130N030		30	215	400	60	25/30/50
F130N032	1 1/4	32	225	400	64	25/30/50
F130N035		35	235	400	70	25/30/50
F130N038	1 1/2	38	255	400	76	25/30/50
F130N040		40	270	400	80	25/30/50
F130N045	1 3/4	45	350	400	90	25/30/50
F130N050		50	405	400	100	25/30/50
F130N051	2	51	405	400	100	25/30/50
F130N055		55	425	400	110	25/30/50

* Working and bursting pressure valid at 20°C / Pression de fonctionnement et limite, à 20 ° C / Presión de trabajo y estallido válida a 20°C / Betriebsdruck und Berstdruck gültig bei 20°C / Рабочее давление и разрывное давление, при 20°C

** Length tolerance +/- 5% / Tolérance de longueur +/- 5% / Tolerancia de longitud +/- 5% / Längentoleranz +/- 5% / Допуск длины +/- 5%

*** Inner Diameter tolerance +/- 2% / Toleranz des inneren Durchmessers +/- 2% / Tolerancia del diámetro interno +/- 2% / Toleranz des inneren Durchmessers +/- 2% / Допуск внутреннего диаметра +/- 2%

 • Other colors are available against MOQ
 • Autres couleurs et longueurs sont disponibles avec la quantité minimale d'un ordre
 • Se ofrecen otros colores y longitudes contra una cantidad mínima de pedido
 • Andere Farben sind gegen Mindestbestellmenge erhältlich
 • В другом цвете возможен при соблюдении минимальных количеств к заказу



131W Air Conditioner Drain Hose

- FR** Tuyau de vidange du climatiseur
- ES** Manguera de drenaje del aire acondicionado
- DE** Ablaufschlauch der Klimaanlage
- RU** Сливной шланг кондиционера

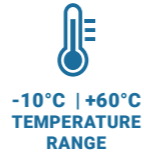

EN This hose can be used for draining out condensation water from air conditioner indoor unit.

FR Ce tuyau peut être utilisé pour vidanger l'eau de condensation du climatiseur.

ES Esta manguera se puede utilizar para drenar agua de condensación del aire acondicionado.

DE Dieser Schlauch kann zum Entleeren verwendet werden Kondenswasser aus der Klimaanlage.

RU Этот шланг можно использовать для слива конденсат из кондиционера.

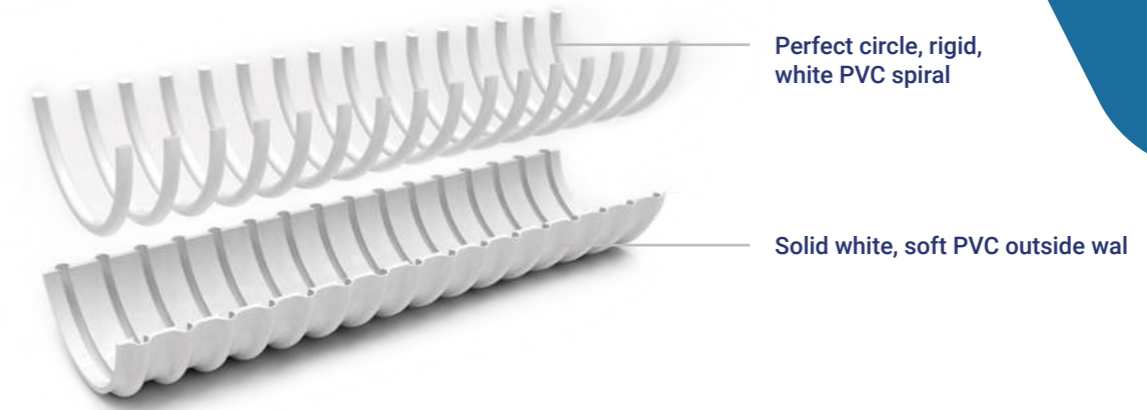

code	inch	mm	gr/m	mbar	mm	m
F131W016	5/8	16	80	400	32	25/30/50
F131W018		18	100	400	36	25/30/50
F131W019	3/4	19	100	400	38	25/30/50

- * **Working and bursting pressure valid at 20°C** / Pression de fonctionnement et limite, à 20 ° C / Presión de trabajo y estallido válida a 20°C / Betriebsdruck und Berstdruck gültig bei 20°C / Рабочее давление и разрывное давление, при 20°C
- ** **Length tolerance +/- 5%** / Tolérance de longueur +/- 5% / Tolerancia de longitud +/- 5% / Längentoleranz +/- 5% / Допуск длины +/- 5%
- *** **Inner Diameter tolerance +/- 2%** / Toleranz des inneren Durchmessers +/- 2% / Tolerancia del diámetro interno +/- 2% / Toleranz des inneren Durchmessers +/- 2% / Допуск внутреннего диаметра +/- 2%

- Other colors are available against MOQ
- Autres couleurs et longueurs sont disponibles avec la quantité minimale d'un ordre
- Se ofrecen otros colores y longitudes contra una cantidad mínima de pedido
- Andere Farben sind gegen Mindestbestellmenge erhältlich
- В другом цвете возможен при соблюдении минимальных количеств к заказу



120N Air, Fume and Dust Ventilation Hose

- FR** Tuyau de ventilation pour air, vapeur et poussière
- ES** Manguera de aspiración de aire, humos y polvo
- DE** Luft-, Rauch- und Staubbeflüchtungs-schlauch
- RU** Вентиляционный шланг для отвода воздуха, испарений и пыли



EN This hose can be used for air ducting, fume extraction, ventilation, air conditioning, vacuum systems and many other industrial applications.

FR Ce tuyau peut être utilisé comme un conduit d'air, pour l'extraction de vapeurs, la ventilation, la climatisation, les systèmes à vide et beaucoup d'autres applications industrielles.

ES Esta manguera se puede usar para conductos de aire, extracción de humos, ventilación, aire acondicionado, sistemas de vacío y muchas otras aplicaciones industriales.

DE Dieser Schlauch kann zur Luftführung, Rauchabsaugung, Lüftung, Klimatisierung, Vakuumanlagen und viele andere industrielle Anwendungen.

RU Этот шланг можно использовать для аспирации, экстракции испарений, вентиляции, кондиционирования воздуха, в вакуумных системах и во множестве иных областях применения в промышленности.

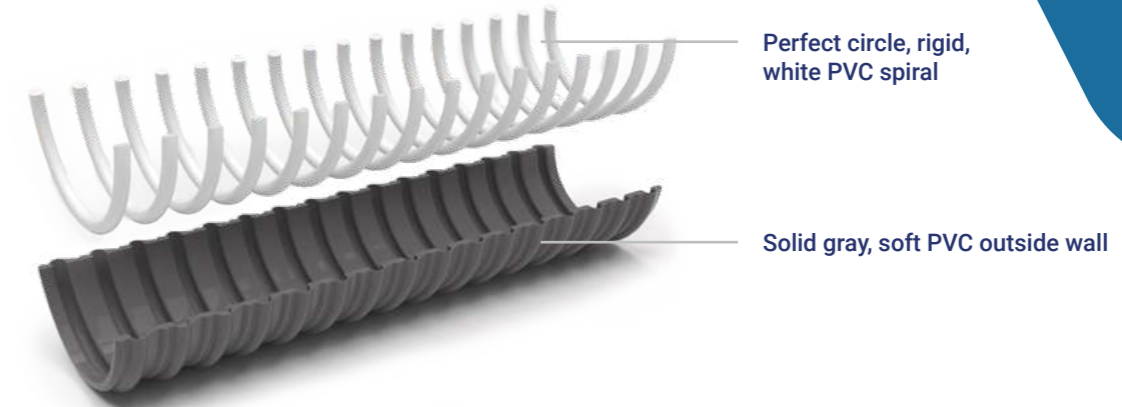

code	inch	mm	gr/m	mbar	mm	m
F120N010		10	65	400	14	25/30/50
F120N013	1/2	13	75	400	18	25/30/50
F120N016	5/8	16	100	400	22	25/30/50
F120N019	3/4	19	115	400	25	25/30/50
F120N020		20	125	400	28	25/30/50
F120N025	1	25	165	400	35	25/30/50
F120N030		30	215	400	42	25/30/50
F120N032	1 1/4	32	225	350	45	25/30/50
F120N035		35	235	350	47	25/30/50
F120N038	1 1/2	38	255	350	50	25/30/50
F120N040		40	270	350	55	25/30/50
F120N045	1 3/4	45	350	350	60	25/30/50
F120N051	2	51	435	350	65	25/30/50
F120N055		55	475	300	70	25/30/50
F120N060		60	525	300	80	25/30/50
F120N063	2 1/2	63	570	300	85	25/30/50
F120N070	2 3/4	70	620	300	95	25/30/50
F120N076	3	76	670	300	100	25/30/50
F120N080		80	755	300	110	25/30/50
F120N090	3 1/2	90	805	300	125	25/30/50
F120N102	4	102	950	300	140	25/30/50
F120N110	4 1/4	110	1065	300	150	25
F120N120		120	1165	300	170	25
F120N127	5	127	1210	300	175	25
F120N140		140	1400	300	196	25
F120N152	6	152	1650	250	200	25

- * Working and bursting pressure valid at 20°C / Pression de fonctionnement et limite, à 20 ° C / Presión de trabajo y estallido válida a 20°C / Betriebsdruck und Berstdruck gültig bei 20°C / Рабочее давление и разрывное давление, при 20°C
- ** Length tolerance +/- 5% / Tolérance de longueur +/- 5% / Tolerancia de longitud +/- 5% / Längentoleranz +/- 5% / Допуск длины +/- 5%
- *** Inner Diameter tolerance +/- 2% / Toleranz des inneren Durchmessers +/- 2% / Tolerancia del diámetro interno +/- 2% / Toleranz des inneren Durchmessers +/- 2% / Допуск внутреннего диаметра +/- 2%



- Other colors are available against MOQ
- Autres couleurs et longueurs sont disponibles avec la quantité minimale d'un ordre
- Se ofrecen otros colores y longitudes contra una cantidad mínima de pedido
- Andere Farben sind gegen Mindestbestellmenge erhältlich
- В другом цвете возможен при соблюдении минимальных количеств к заказу

161N Vacuum Ventilation Hose

FR Tuyau de ventilation à vide
 ES Manguera de ventilación de vacío
 DE Vakuüm-Entlüftungsschlauch
 RU Вакуумный вентиляционный шланг

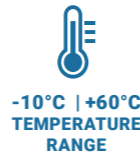
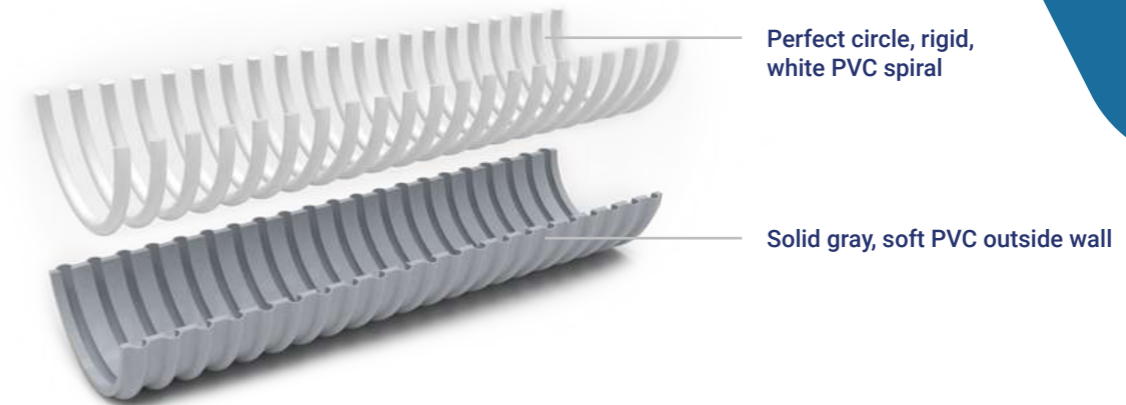

EN This hose can be used for air ducting, dust and fume extraction suction of sawdust and yarns in textile industry, ventilation, industrial and domestic vacuum cleaning equipment.

FR Ce tuyau peut être utilisé comme un conduit d'air, pour l'extraction de poussière de la sciure et des fils dans l'industrie textile, la ventilation, les aspirateurs industriels et domestiques.

ES Esta manguera se puede usar para Conductos de aire, aspiración depolvo y humo de aserrín e hilos en la industria textil, ventilación, equipos de limpieza al vacío industriales y domésticos.

DE Dieser Schlauch kann zur Luftführung, Staub- und Rauchabsaugung von Sägemehl und Garnen in der Textilindustrie, Lüftung, industriellen und häuslichen Staubsauganlagen.

RU Этот шланг можно использовать для аспирации, экстракции пыли и испарений, всасывании древесных стружек и волокон в текстильной промышленности, вентиляции, для промышленных и домашних пылесосов.

code	inch	mm	gr/m	mbar	mm	m
F161N025	1	25	190	500	38	25/30/50
F161N030		32	230	500	45	25/30/50
F161N032	1 1/4	32	260	500	48	25/30/50
F161N035		35	290	500	52	25/30/50
F161N038	1 1/2	38	330	500	57	25/30/50
F161N040		40	360	400	60	25/30/50
F161N045	1 3/4	45	400	400	68	25/30/50
F161N051	2	51	440	400	76	25/30/50
F161N055		55	500	400	82	25/30/50
F161N060		60	540	400	90	25/30/50
F161N063	2 1/2	63	600	400	95	25/30/50
F161N070	2 3/4	70	680	400	105	25/30/50
F161N076	3	76	720	400	114	25/30/50
F161N080		80	780	400	120	25/30/50
F161N090	3 1/2	90	900	400	135	25/30/50
F161N102	4	102	1050	400	153	25/30/50
F161N110	4 1/4	110	1180	300	165	25
F161N120		120	1300	300	180	25
F161N127	5	127	1380	300	190	25
F161N140		140	1600	300	210	25
F161N152	6	152	1750	250	228	25

* Working and bursting pressure valid at 20°C / Pression de fonctionnement et limite, à 20 ° C / Presión de trabajo y estallido válida a 20°C / Betriebsdruck und Berstdruck gültig bei 20°C / Рабочее давление и разрывное давление, при 20°C

** Length tolerance +/- 5% / Tolérance de longueur +/- 5% / Tolerancia de longitud +/- 5% / Längentoleranz +/- 5% / Допуск длины +/- 5%

*** Inner Diameter tolerance +/- 2% / Toleranz des inneren Durchmessers +/- 2% / Tolerancia del diámetro interno +/- 2% / Toleranz des inneren Durchmessers +/- 2% / Допуск внутреннего диаметра +/- 2%

Other colors are available against MOQ
 Autres couleurs et longueurs sont disponibles avec la quantité minimale d'un ordre
 Se ofrecen otros colores y longitudes contra una cantidad mínima de pedido
 Andere Farben sind gegen Mindestbestellmenge erhältlich
 В другом цвете возможен при соблюдении минимальных количеств к заказу





Technical

Technique | Técnicos
Technisch | Технические

330M Pressure Spray Braided Hose 20 bar

FR Tuyau tressé à haute pression
 ES Manguera trenzada de altapresión
 DE Drucksprüh-Geflechtschlauch
 RU Оплетенный поливочный шланг ПВХ

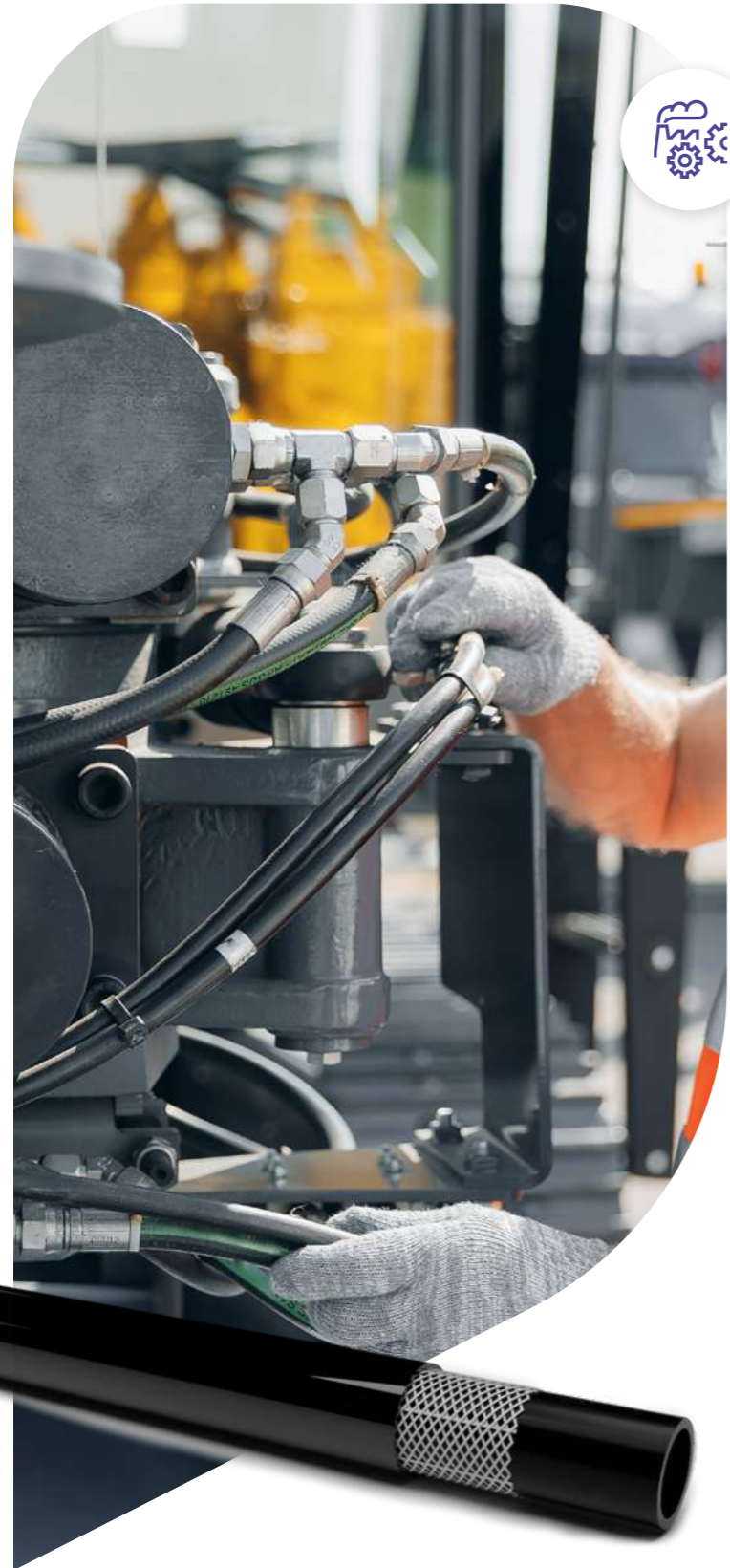

-10°C | +60°C
TEMPERATURE RANGE

HIGH PRESSURE RESISTANCE

EN This hose can be used for compressed air and hydraulic systems, pneumatic tools, spray and carwash guns.

FR Ce tuyau peut être utilisé pour les systèmes d'air comprimé et les systèmes hydrauliques, les outils pneumatiques, les pistolets de pulvérisation et les nettoyeurs haute pression.

ES Esta manguera se puede usar para sistemas de aire comprimido o hidráulicos, herramientas neumáticas, pulverizadores y pistolas de lavado de automóviles.

DE Dieser Schlauch kann für Druckluft- und Hydrauliksysteme, Druckluftwerkzeuge, Spritz- und Autowaschpistolen verwendet werden.

RU Этот шланг можно использовать для систем подачи сжатого воздуха и гидравлических систем, пневматических инструментов, пистолетов-разбрызгивателей и автомоек.

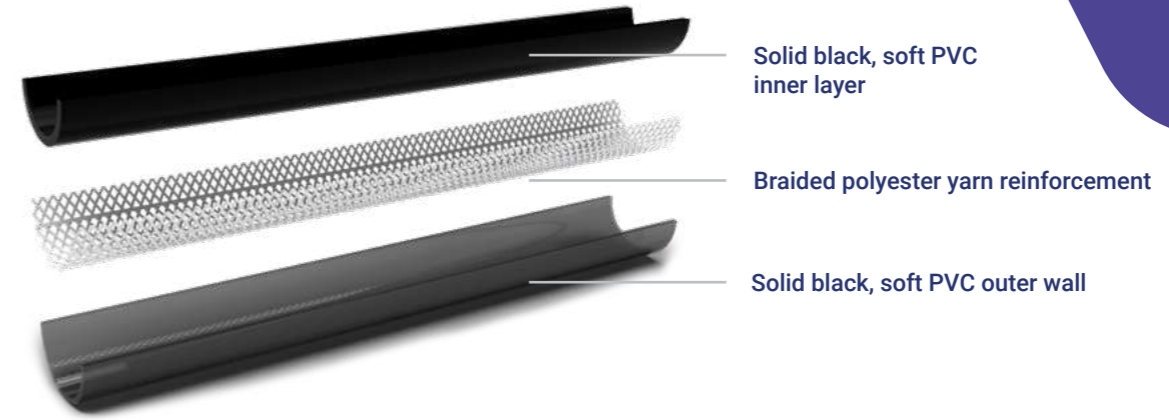

code	inch	mm	mm	gr/m	bar	m
V330M006	1/4	6	12,2	115	20	20/50/100
V330M008	5/16	8	14,3	130	20	20/50/100
V330M010	3/8	10	16,3	158	20	20/50/100
V330M013	1/2	13	19,3	196	20	20/50/100
V330M016	5/8	16	22,3	245	20	20/50/100
V330M019	3/4	19	26,3	310	15	20/50/100

* **Working and bursting pressure valid at 20°C** / Pression de fonctionnement et limite, à 20° C / Presión de trabajo y estallido válida a 20°C / Betriebsdruck und Berstdruck gültig bei 20°C / Рабочее давление и разрывное давление, при 20°C
 ** **Length tolerance +/- 5%** / Tolérance de longueur +/- 5% / Tolerancia de longitud +/- 5% / Längentoleranz +/- 5% / Допуск длины +/- 5%
 *** **Inner Diameter tolerance +/- 2%** / Tolérance de diamètre interne +/- 2% / Tolerancia del diámetro interno +/- 2% / Toleranz des inneren Durchmessers +/- 2% / Допуск внутреннего диаметра +/- 2%

Other colors are available against MOQ
 • Autres couleurs et longueurs sont disponibles avec la quantité minimale d'un ordre
 • Se ofrecen otros colores y longitudes contra una cantidad mínima de pedido
 • Andere Farben sind gegen Mindestbestellmenge erhältlich
 • В другом цвете возможен при соблюдении минимальных количеств к заказу



340N Pressure Spray Braided Hose 30 bar



FR Tuyau tressé à haute pression
 ES Manguera trenzada de altapresión
 DE Drucksprüh-Geflechtschlauch
 RU Оплетенный поливочный шланг ПВХ



 **-10°C | +60°C**
TEMPERATURE RANGE

 **HIGH PRESSURE**
RESISTANCE

EN This hose can be used for compressed air and hydraulic systems, pneumatic tools, spray and carwash guns.

FR Ce tuyau peut être utilisé pour les systèmes d'air comprimé et les systèmes hydrauliques, les outils pneumatiques, les pistolets de pulvérisation et les nettoyeurs haute pression.

ES Esta manguera se puede usar para sistemas de aire comprimido o hidráulicos, herramientas neumáticas, pulverizadores y pistolas de lavado de automóviles.

DE Dieser Schlauch kann für Druckluft- und Hydrauliksysteme, Druckluftwerkzeuge, Spritz- und Autowaschpistolen verwendet werden.

RU Этот шланг можно использовать для систем подачи сжатого воздуха и гидравлических систем, пневматических инструментов, пистолетов-разбрызгивателей и автомоек.



code	inch	mm	mm	gr/m	bar	bar	m
V330M006	1/4	6	11,6	100	30	90	25/50/100
V330M008	5/16	8	13,8	130	30	90	25/50/100
V330M010	3/8	10	16,2	160	30	90	25/50/100
V330M013	1/2	13	19,6	200	30	90	25/50/100
V330M016	5/8	16	22,6	245	30	90	25/50/100
V330M019	3/4	19	26,2	320	30	90	25/50/100

* **Working and bursting pressure valid at 20°C** / Pression de fonctionnement et limite, à 20° C / Presión de trabajo y estallido válida a 20°C / Betriebsdruck und Berstdruck gültig bei 20°C / Рабочее давление и разрывное давление, при 20°C

** **Length tolerance +/- 5%** / Tolérance de longueur +/- 5% / Tolerancia de longitud +/- 5% / Längentoleranz +/- 5% / Допуск длины +/- 5%

*** **Inner Diameter tolerance +/- 2%** / Tolérance de diamètre interne +/- 2% / Tolerancia del diámetro interno +/- 2% / Toleranz des inneren Durchmessers +/- 2% / Допуск внутреннего диаметра +/- 2%

 • Other colors are available against MOQ
 • Autres couleurs et longueurs sont disponibles avec la quantité minimale d'un ordre
 • Se ofrecen otros colores y longitudes contra una cantidad mínima de pedido
 • Andere Farben sind gegen Mindestbestellmenge erhältlich
 • В другом цвете возможен при соблюдении минимальных количеств к заказу



380N Pressure Spray Braided Hose 50 bar



- FR** Tuyau tressé à haute pression
- ES** Manguera trenzada de altapresión
- DE** Drucksprüh-Geflechtschlauch
- RU** Оплетенно-напорный шланг ПВХ для высокого давления



-10°C | +60°C
TEMPERATURE RANGE

HIGH PRESSURE
RESISTANCE

EN This hose can be used for compressed air and hydraulic systems, pneumatic tools, spray and carwash guns.

FR Ce tuyau peut être utilisé pour les systèmes d'air comprimé et les systèmes hydrauliques, les outils pneumatiques, les pistolets de pulvérisation et les nettoyeurs haute pression.

ES Esta manguera se puede usar para sistemas de aire comprimido o hidráulicos, herramientas neumáticas, pulverizadores y pistolas de lavado de automóviles.

DE Dieser Schlauch kann für Druckluft- und Hydrauliksysteme, Druckluftwerkzeuge, Spritz- und Autowaschpistolen verwendet werden.

RU Этот шланг можно использовать для систем подачи сжатого воздуха и гидравлических систем, пневматических инструментов, пистолетов-разбрызгивателей и автомоек.

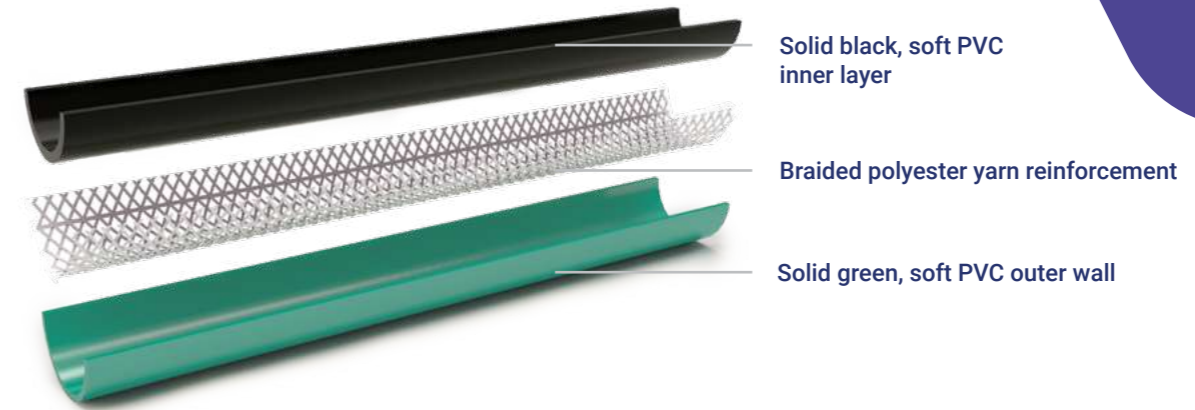

Solid black, soft PVC inner layer

Braided polyester yarn reinforcement

Solid green, soft PVC outer wall

code	inch	mm	mm	gr/m	bar	bar	m
V380N008	5/16	8	15	160	50	140	25/50/100
V380N010	3/8	10	17,2	200	50	140	25/50/100
V380N013	1/2	13	22	300	50	140	25/50/100

* **Working and bursting pressure valid at 20°C** / Pression de fonctionnement et limite, à 20° C / Presión de trabajo y estallido válida a 20°C / Betriebsdruck und Berstdruck gültig bei 20°C / Рабочее давление и разрывное давление, при 20°C

** **Length tolerance +/- 5%** / Tolérance de longueur +/- 5% / Tolerancia de longitud +/- 5% / Längentoleranz +/- 5% / Допуск длины +/- 5%

*** **Inner Diameter tolerance +/- 2%** / Tolérance de diamètre interne +/- 2% / Tolerancia del diámetro interno +/- 2% / Toleranz des inneren Durchmessers +/- 2% / Допуск внутреннего диаметра +/- 2%



- Other colors are available against MOQ
- Autres couleurs et longueurs sont disponibles avec la quantité minimale d'un ordre
- Se ofrecen otros colores y longitudes contra una cantidad mínima de pedido
- Andere Farben sind gegen Mindestbestellmenge erhältlich
- В другом цвете возможен при соблюдении минимальных количеств к заказу



210N Double Layer PVC Layflat Hose



FR Tuyau plat en PVC à double couche
ES Manguera Layflat de PVC de doble capa
DE Doppelschichtiger PVC Flachschauch
RU Двухслойный напорный плоский шланг ПВХ

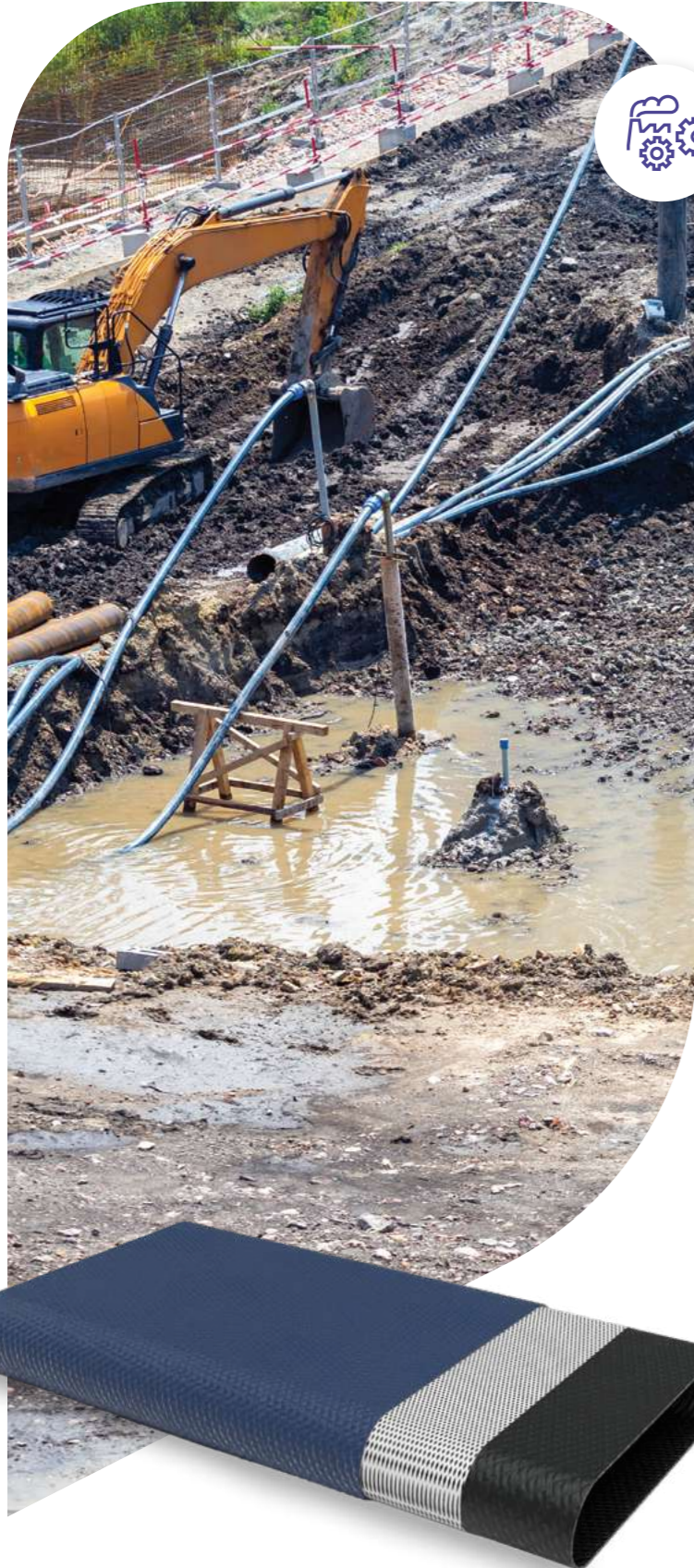

- 10°C | +60°C**
TEMPERATURE RANGE
- HIGH PRESSURE RESISTANCE**
- UV RESISTANT**
- EASY TO STORE AND INSTALL**

EN This hose can be used for:
 1. Water discharge in dewatering projects and industry
 2. Water delivery or supply of liquid fertilizers and other agricultural chemicals
 3. Surface irrigation systems and sprinklers

FR Ce tuyau peut être utilisé pour:
 1. Évacuation d'eau dans les projets et les installations de drainage.
 2. Transport d'eau ou approvisionnement en engrais liquides et en autres produits chimiques agricoles
 3. Systèmes d'irrigation de surface et de pulvérisation

ES Esta manguera se puede usar para:
 1. Descarga de agua en proyectos de deshidratación e industria.
 2. Suministro de agua o suministro de fertilizantes líquidos y otros productos químicos agrícolas
 3. Sistemas de irrigación de superficie y rociadores."

DE Dieser Schlauch kann verwendet werden als:
 1. Wasserableitung in Entwässerungsprojekten und in der Industrie
 2. Wasserversorgung oder Lieferung von Flüssigdüngern und anderen Agrarchemikalien
 3. Oberflächenbewässerungssysteme und Sprinkleranlagen

RU Области применения шланга:
 1. Водоспуск на объектах водоотлива и промышленности
 2. Транспортировка воды или подача жидких удобрений и других сельскохозяйственных химикатов
 3. Наземные системы орошения и разбрызгивания

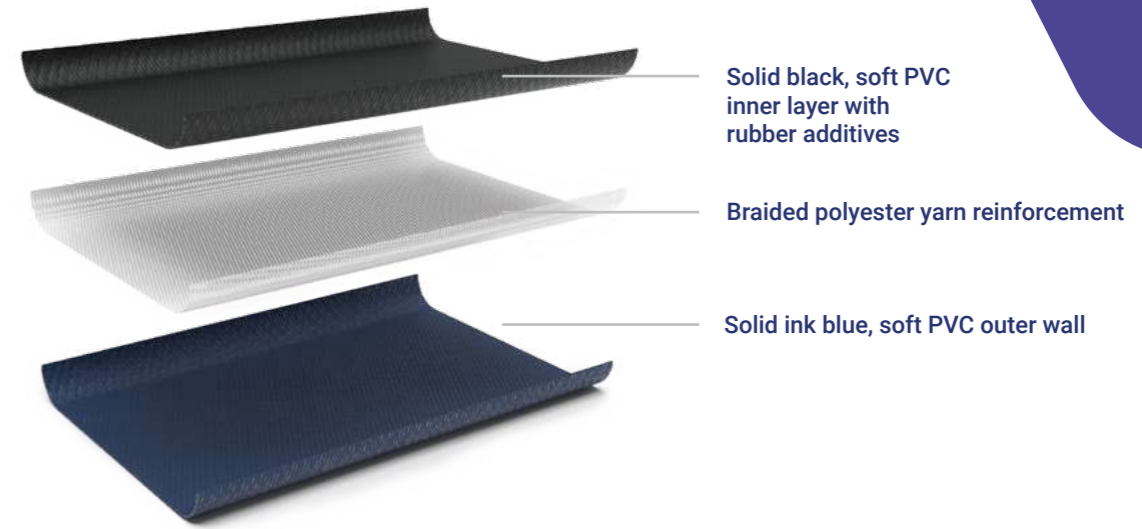

code	inch	mm	gr/m	bar	bar	m
L210N038	1 1/2	38	350	10	30	50/100
L210N040		40	330	10	30	50/100
L210N045	1 3/4	45	400	10	30	50/100
L210N051	2	51	460	10	30	50/100
L210N063	2 1/2	63	600	10	30	50/100
L210N076	3	76	700	10	30	50/100
L210N102	4	102	1100	10	30	50/100
L210N153	6	153	1800	8	24	50
L210N203	8	203	2800	8	24	50

- * **Working and bursting pressure valid at 20°C** // Pression de fonctionnement et limite, à 20 ° C / Presión de trabajo y estallido válida a 20°C / Betriebsdruck und Berstdruck gültig bei 20°C / Рабочее давление и разрывное давление, при 20°C
- ** **Length tolerance +/- 5%** / Tolérance de longueur +/- 5% / Tolerancia de longitud +/- 5% / Längentoleranz +/- 5% / Допуск длины +/- 5%
- *** **Inner Diameter tolerance +/- 2%** / Tolérance de diamètre interne +/- 2% / Tolerancia del diámetro interno +/- 2% / Toleranz des inneren Durchmessers +/- 2% / Допуск внутреннего диаметра +/- 2%

- Other colors are available against MOQ
- Autres couleurs et longueurs sont disponibles avec la quantité minimale d'un ordre
- Se ofrecen otros colores y longitudes contra una cantidad mínima de pedido
- Andere Farben sind gegen Mindestbestellmenge erhältlich
- В другом цвете возможен при соблюдении минимальных количеств к заказу



216N Double Layer PVC Layflat Hose



FR Tuyau plat en PVC à double couche
ES Manguera Layflat de PVC de doble capa
DE Doppelschichtiger PVC Flachschauch
RU Двухслойный напорный плоский шланг ПВХ



- 
-10°C | +60°C
TEMPERATURE RANGE
- 
HIGH PRESSURE RESISTANCE
- 
UV RESISTANT
- 
EASY TO STORE AND INSTALL

EN This hose can be used for:
 1. Heavy duty water discharge in dewatering projects, mining and industry.
 2. Water delivery or supply of liquid fertilizers and other agricultural chemicals
 3. Delivery of concrete and other Construction consumables

FR Ce tuyau peut être utilisé pour:
 1. Évacuation d'eau dans les systèmes de drainage fonctionnant dans des conditions difficiles, des projets, mines et dans l'industrie.
 3. Approvisionnement en béton et en autres matériaux de construction

ES Esta manguera se puede usar para:
 1. Descarga de agua de alta resistencia en proyectos dedeshidratación, minería e industria.
 2. Suministro de agua o suministro de fertilizantes líquidos y otros productos químicos agrícolas
 3. Entrega de hormigón y otros materiales de construcción

DE Dieser Schlauch kann verwendet werden als:
 1. Hochleistungswasserableitung in Entwässerungsprojekten, im Bergbau und in der Industrie
 2. Wasserversorgung oder Lieferung von Flüssigdüngern und anderen Agrarchemikalien
 3. Lieferung von Beton und anderen Bauhilfsmitteln

RU Области применения шланга:
 1. Слив воды в дренажных системах, на объектах, работающих в тяжелых условиях, шахтах, в промышленности
 2. Транспортировка воды или подача жидких удобрений и других сельскохозяйственных химикатов
 3. Подача бетона и других строительных материалов

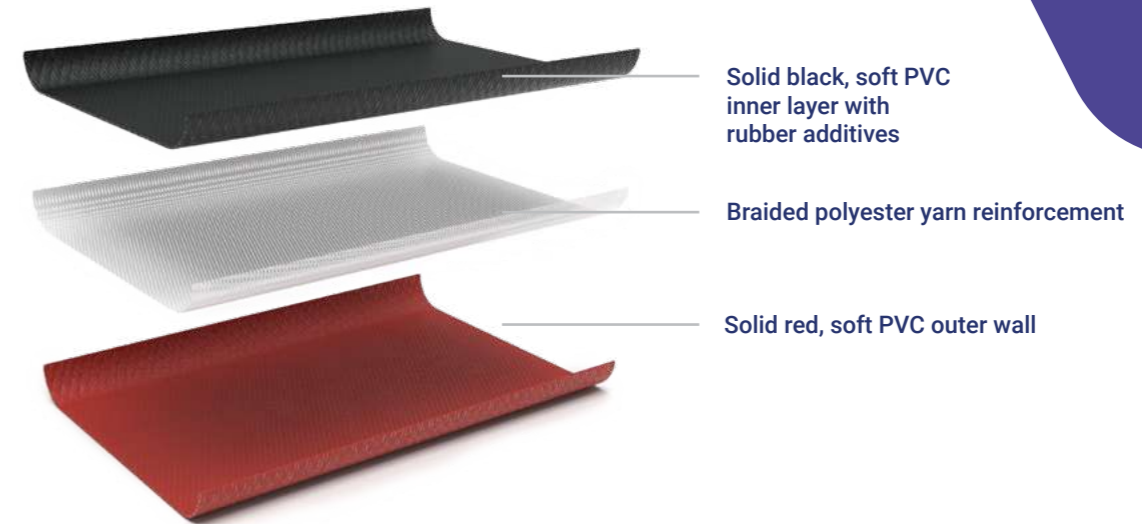

code	inch	mm	gr/m	bar	bar	m
L216N025	1	25	260	16	48	50/100
L216N035		35	360	16	48	50/100
L216N038	1 1/2	38	400	16	48	50/100
L216N040		40	440	16	48	50/100
L216N045	1 3/4	45	480	16	48	50/100
L216N051	2	51	550	16	48	50/100
L216N063	2 1/2	63	760	16	48	50/100
L216N076	3	76	860	13	38	50/100
L216N080		80	920	13	38	50/100
L216N090	3 1/2	90	1060	13	38	50/100
L216N102	4	102	1250	13	38	50/100
L216N153	6	153	2450	10	30	50
L216N203	8	203	3500	5	15	50

* **Working and bursting pressure valid at 20°C** // Pression de fonctionnement et limite, à 20 ° C / Presión de trabajo y estallido válida a 20°C / Betriebsdruck und Berstdruck gültig bei 20°C / Рабочее давление и разрывное давление, при 20°C
 ** **Length tolerance +/- 5%** / Tolérance de longueur +/- 5% / Tolerancia de longitud +/- 5% / Längentoleranz +/- 5% / Допуск длины +/- 5%
 *** **Inner Diameter tolerance +/- 2%** / Tolérance de diamètre interne +/- 2% / Tolerancia del diámetro interno +/- 2% / Toleranz des inneren Durchmessers +/- 2% / Допуск внутреннего диаметра +/- 2%

 • Other colors are available against MOQ
 • Autres couleurs et longueurs sont disponibles avec la quantité minimale d'un ordre
 • Se ofrecen otros colores y longitudes contra una cantidad mínima de pedido
 • Andere Farben sind gegen Mindestbestellmenge erhältlich
 • В другом цвете возможен при соблюдении минимальных количеств к заказу





Construction

Construction | Construcción
Konstruktion | Строительство

015S Superelastic Slurry Hose



FR Tuyau super élastique pour suspension
ES Manguera de lodo superelástica
DE Superelastischer Gülle-Schlauch
RU Суперэластичный шланг для растворов

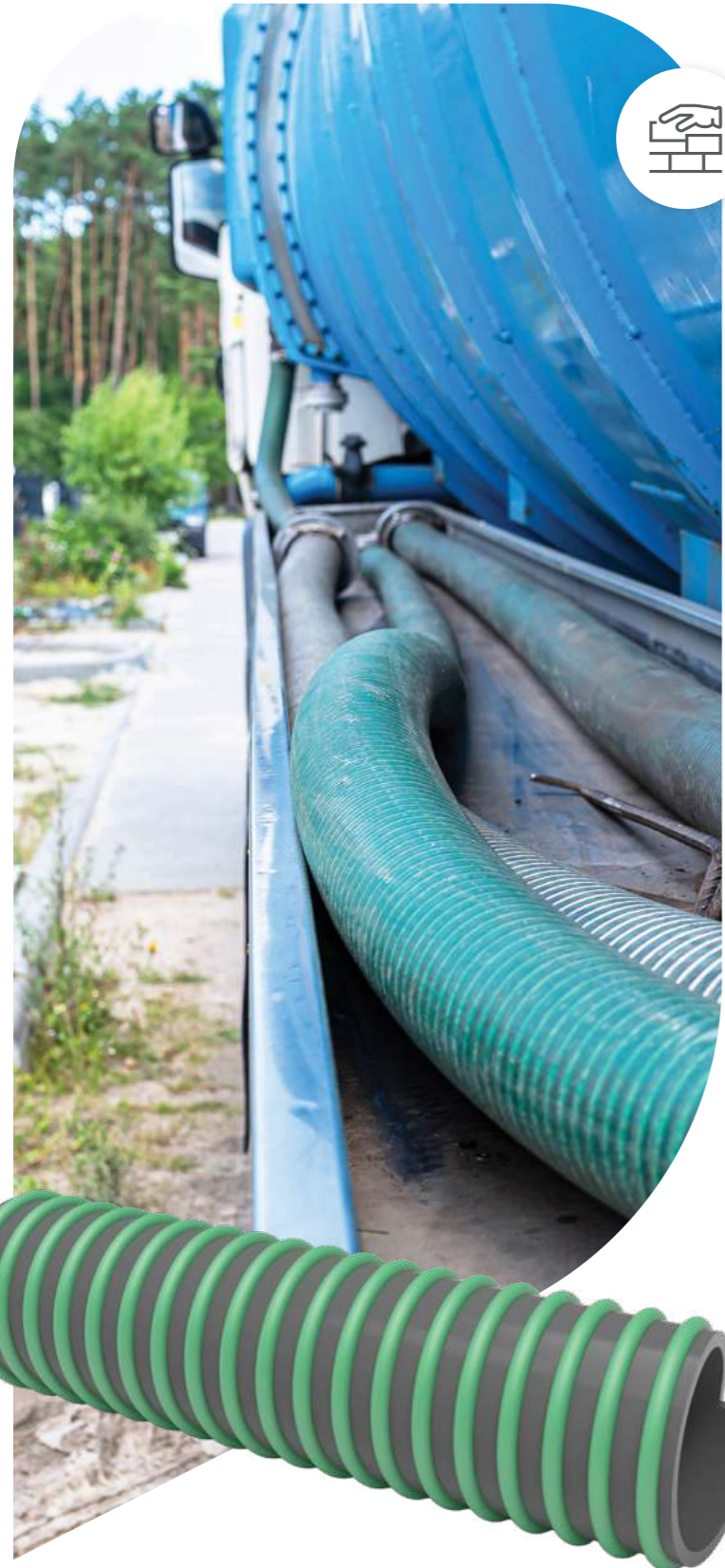

-20°C | +60°C
TEMPERATURE RANGE

HIGH FLEXIBILITY

SMOOTH INSIDE

TEMPERATURE RESISTANCE

LOW TRACTION

EN This hose can be used for suction especially for tank cars, irrigation plants and sludge tankers.

FR Ce tuyau peut être utilisé comme un tuyau d'aspiration pour les réservoirs automobiles, les systèmes d'irrigation et les bassins de sédimentation.

ES Esta manguera se puede utilizar para la succión, especialmente para cisternas, plantas de riego y cisternas de lodo.

DE Dieser Schlauch kann zur Absaugung insbesondere für Kesselwagen, Bewässerungsanlagen und Schlamm-tanker verwendet werden.

RU Этот шланг можно использовать как всасывающий шланг для автоцистерн, оросительной установки и цистерн для жидкого удобрения.

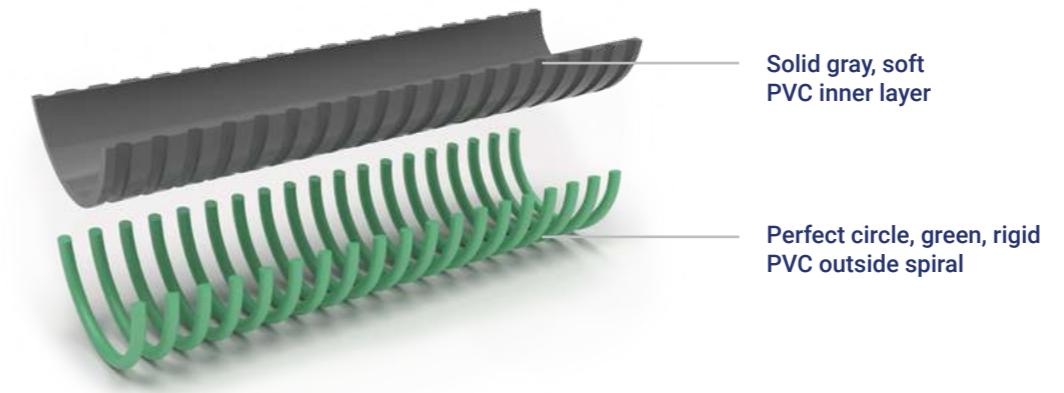

code	inch	mm	gr/m	bar	mbar	mm	m
F015S019	3/4	19	350	6	900	80	25/30/50
F015S025	1	25	440	5	900	87	25/30/50
F015S032	1 1/4	32	580	5	900	112	25/30/50
F015S035		35	640	4,5	900	120	25/30/50
F015S038	1 1/2	38	670	4,5	900	133	25/30/50
F015S040		40	730	4,5	900	140	25/30/50
F015S045	1 3/4	45	870	4	900	160	25/30/50
F015S051	2	51	1000	4	900	176	25/30/50
F015S060		60	1250	3,5	800	210	25/30/50
F015S063	2 1/2	63	1350	3,5	800	220	25/30/50
F015S070	2 1/2	70	1580	3,5	800	245	25/30/50
F015S076	3	76	1700	3,5	800	262	25/30/50
F015S080		80	1810	3,5	800	280	25/30/50
F015S090	3 1/2	90	2080	3	800	315	25/30
F015S102	4	102	2600	2,5	800	357	25/30
F015S110		110	3000	2,5	800	385	25
F015S120		120	3350	2,5	800	420	25
F015S127	5	127	3600	2,5	800	437	25
F015S152	6	152	4900	2	800	525	25

* Working and bursting pressure valid at 20°C // Pression de fonctionnement et limite, à 20 ° C / Presión de trabajo y estallido válida a 20°C / Betriebsdruck und Berstdruck gültig bei 20°C / Рабочее давление и разрывное давление, при 20°C

** Length tolerance +/- 5% / Tolérance de longueur +/- 5% / Tolerancia de longitud +/- 5% / Längentoleranz +/- 5% / Допуск длины +/- 5%

*** Inner Diameter tolerance +/- 2% / Tolérance de diamètre interne +/- 2% / Tolerancia del diámetro interno +/- 2% / Toleranz des inneren Durchmessers +/- 2% / Допуск внутреннего диаметра +/- 2%

• Other colors are available against MOQ
 • Autres couleurs et longueurs sont disponibles avec la quantité minimale d'un ordre
 • Se ofrecen otros colores y longitudes contra una cantidad mínima de pedido
 • Andere Farben sind gegen Mindestbestellmenge erhältlich
 • В другом цвете возможен при соблюдении минимальных количеств к заказу



015SSM Extreme Elastic Slurry Hose



FR Tuyau à lisier extrêmement élastique
ES Manguera para lodo extremadamente elástica
DE Extrem elastischer Gülleschlauch
RU Экстремально эластичный шланг для

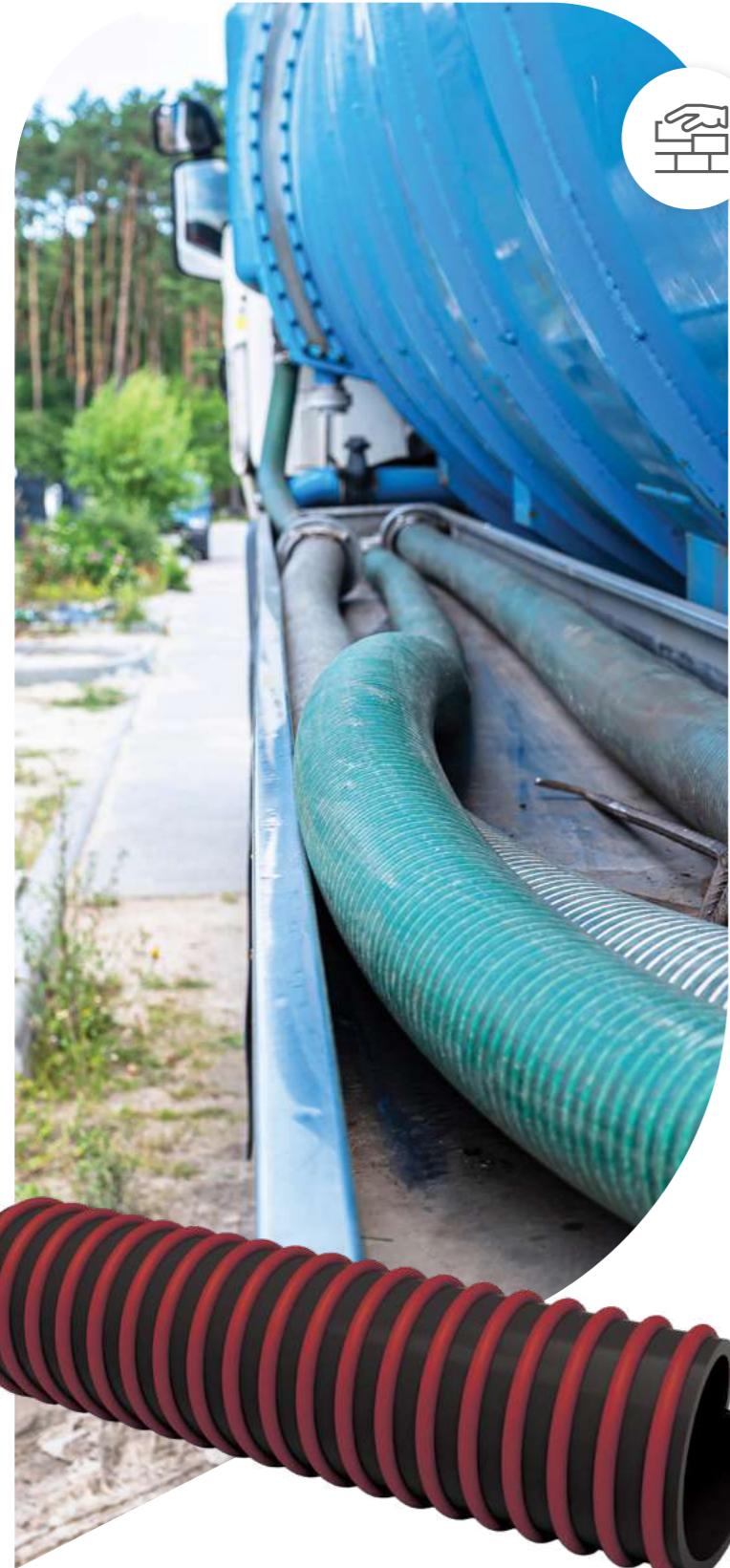

 **-40°C | +60°C**
TEMPERATURE RANGE

 **HIGH FLEXIBILITY**

 **SMOOTH INSIDE**

 **TEMPERATURE RESISTANCE**

 **LOW TRACTION**

EN This hose can be used for suction especially for tank cars, irrigation plants and sludge tankers.

FR Ce tuyau peut être utilisé comme un tuyau d'aspiration pour les réservoirs automobiles, les systèmes d'irrigation et les bassins de sédimentation.

ES Esta manguera se puede utilizar para la succión, especialmente para cisternas, plantas de riego y cisternas de lodo.

DE Dieser Schlauch kann zur Absaugung insbesondere für Kesselwagen, Bewässerungsanlagen und Schlammtanker verwendet werden.

RU Этот шланг можно использовать как всасывающий шланг для автоцистерн, оросительной установки и цистерн для жидкого удобрения.

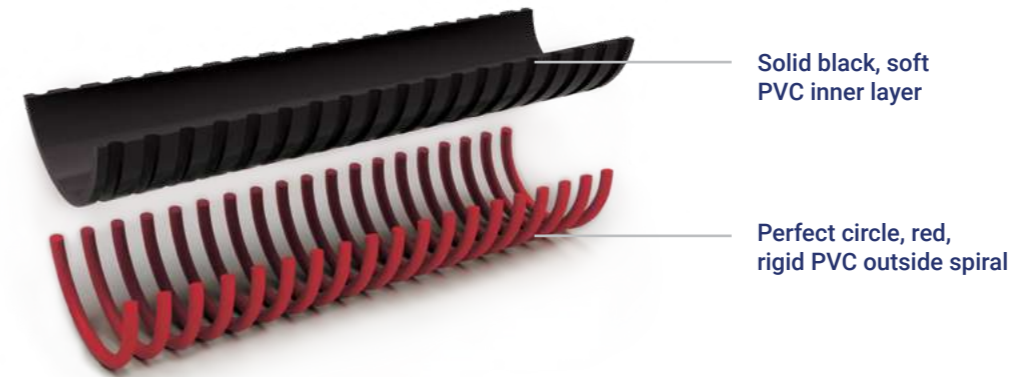

Solid black, soft PVC inner layer

Perfect circle, red, rigid PVC outside spiral

code	inch	mm	gr/m	bar	mbar	mm	m
F015SSM019	3/4	19	350	4,5	900	80	25/50
F015SSM025	1	25	440	4,5	900	87	25/50
F015SSM032	1 1/4	32	580	4	900	112	25/50
F015SSM035		35	640	4	900	120	25/50
F015SSM038	1 1/2	38	670	4	900	133	25/50
F015SSM040		40	730	4	900	140	25/50
F015SSM045	1 3/4	45	870	4	900	160	25/50
F015SSM051	2	51	1000	4	900	176	25/50
F015SSM060		60	1250	3	800	210	25/50
F015SSM063	2 1/2	63	1350	3	800	220	25/50
F015SSM070	2 1/2	70	1580	3	800	245	25/50
F015SSM076	3	76	1700	3	800	262	25/50
F015SSM080		80	1810	3	800	280	25/50
F015SSM090	3 1/2	90	2080	3	800	315	25
F015SSM102	4	102	2600	2,5	800	357	25
F015SSM110		110	3000	2,5	800	385	25
F015SSM120		120	3350	2	800	420	25
F015SSM127	5	127	3600	2	800	437	25
F015SSM152	6	152	4900	2	800	525	25

* **Working and bursting pressure valid at 20°C** // Pression de fonctionnement et limite, à 20 ° C / Presión de trabajo y estallido válida a 20°C / Betriebsdruck und Berstdruck gültig bei 20°C / Рабочее давление и разрывное давление, при 20°C
 ** **Length tolerance +/- 5%** / Tolérance de longueur +/- 5% / Tolerancia de longitud +/- 5% / Längentoleranz +/- 5% / Допуск длины +/- 5%
 *** **Inner Diameter tolerance +/- 2%** / Tolérance de diamètre interne +/- 2% / Tolerancia del diámetro interno +/- 2% / Toleranz des inneren Durchmessers +/- 2% / Допуск внутреннего диаметра +/- 2%

 • Other colors are available against MOQ
 • Autres couleurs et longueurs sont disponibles avec la quantité minimale d'un ordre
 • Se ofrecen otros colores y longitudes contra una cantidad mínima de pedido
 • Andere Farben sind gegen Mindestbestellmenge erhältlich
 • В другом цвете возможен при соблюдении минимальных количеств к заказу



010SSZ Extreme Elastic Suction Hose



FR Tuyau d'aspiration extrêmement flexible
 ES Manguera de succión extremadamente flexible
 DE Extrem elastischer Saugschlauch
 RU Сверхэластичный всасывающий шланг



-40°C | +60°C
TEMPERATURE RANGE

HIGH FLEXIBILITY

LOW TEMPERATURE RESISTANCE

EN This hose can be used for suction and delivery in conveying water and other liquid or solid materials in very low temperatures.

FR Ce tuyau peut être utilisé comme un tuyau d'aspiration et de transport pour eau et d'autres liquides ou matières solides à une très basse température.

ES Esta manguera se puede utilizar para succión y entrega en el transporte de agua y otros materiales líquidos o sólidos a temperaturas muy bajas.

DE Dieser Schlauch kann zum Ansaugen und Fördern von Wasser und anderen Flüssigkeiten oder Feststoffe in der Landwirtschaft oder im Bauwesen verwendet werden bei niedrigen Temperaturen.

RU Этот шланг можно использовать для всасывания и транспортировки воды и других жидкостей или твердых материалов в сельском хозяйстве и строительстве в условиях низкой температуры.

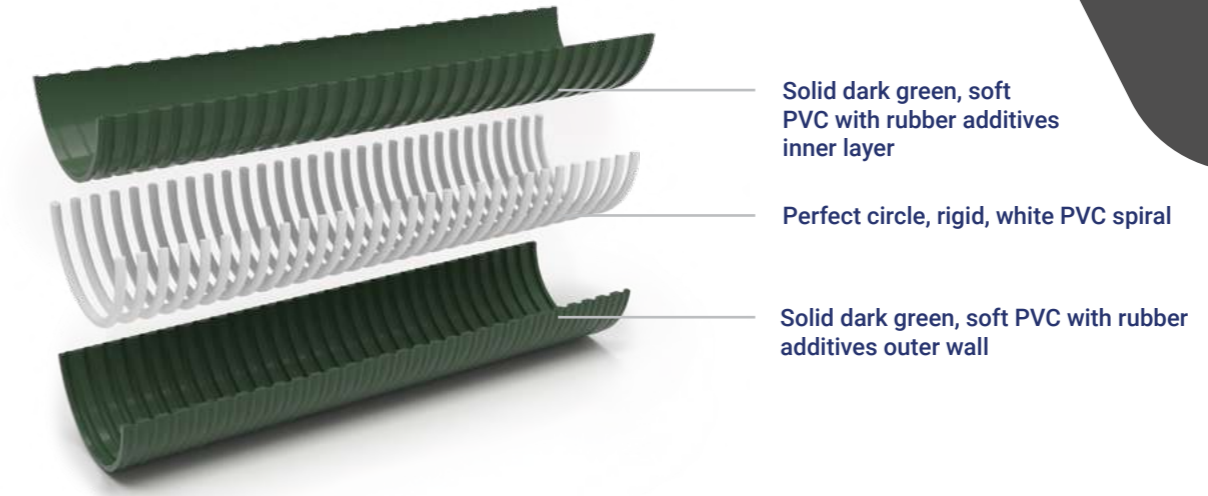

code	inch	mm	gr/m	bar	mbar	mm	m
F010SSZ019	3/4	19	335	4,5	900	45	25/30/50
F010SSZ020		20	335	4,5	900	50	25/30/50
F010SSZ025	1	25	400	4,5	900	60	25/30/50
F010SSZ030		30	535	4	900	72	25/30/50
F010SSZ032	1 1/4	32	580	4	900	75	25/30/50
F010SSZ038	1 1/2	38	680	4	900	90	25/30/50
F010SSZ040		40	710	4	900	95	25/30/50
F010SSZ045	1 3/4	45	815	4	900	110	25/30/50
F010SSZ051	2	51	970	4	900	120	25/30/50
F010SSZ055		55	1065	3,5	900	133	25/30/50
F010SSZ060		60	1240	3,5	900	145	25/30/50
F010SSZ063	2 1/2	63	1405	3,5	800	150	25/30/50
F010SSZ070		70	1550	3,5	800	165	25/30/50
F010SSZ076	3	76	1680	3	800	175	25/30/50
F010SSZ080		80	1795	3	800	190	25/30
F010SSZ090	3 1/2	90	2055	3	800	215	25/30
F010SSZ102	4	102	2600	2,5	800	235	25/30
F010SSZ110	4 1/2	110	2910	2,5	800	259	25
F010SSZ120		120	3200	2	800	285	25
F010SSZ127	5	127	3395	2	800	300	25
F010SSZ152	6	152	5000	2	800	400	25

* Working and bursting pressure valid at 20°C / Pression de fonctionnement et limite, à 20 ° C / Presión de trabajo y estallido válida a 20°C / Betriebsdruck und Berstdruck gültig bei 20°C / Рабочее давление и разрывное давление, при 20°C

** Length tolerance +/- 5% / Tolérance de longueur +/- 5% / Tolerancia de longitud +/- 5% / Längentoleranz +/- 5% / Допуск длины +/- 5%

*** Inner Diameter tolerance +/- 2% / Tolérance de diamètre interne +/- 2% / Tolerancia del diámetro interno +/- 2% / Toleranz des inneren Durchmessers +/- 2% / Допуск внутреннего диаметра +/- 2%

Other colors are available against MOQ
 • Autres couleurs et longueurs sont disponibles avec la quantité minimale d'un ordre
 • Se ofrecen otros colores y longitudes contra una cantidad mínima de pedido
 • Andere Farben sind gegen Mindestbestellmenge erhältlich
 • В другом цвете возможен при соблюдении минимальных количеств к заказу



Liquids and Abrasives Heavy Suction & Delivery Hose

FR Tuyau d'aspiration et de refoulement lourd pour liquides et abrasifs
ES Manguera pesada de succión y entrega de líquidos y abrasivos
DE Schwerer Saug- und Druckschlauch für Flüssigkeiten und Schleifmittel
RU Тяжелый всасывающий и напорный шланг для жидкостей и абразивов

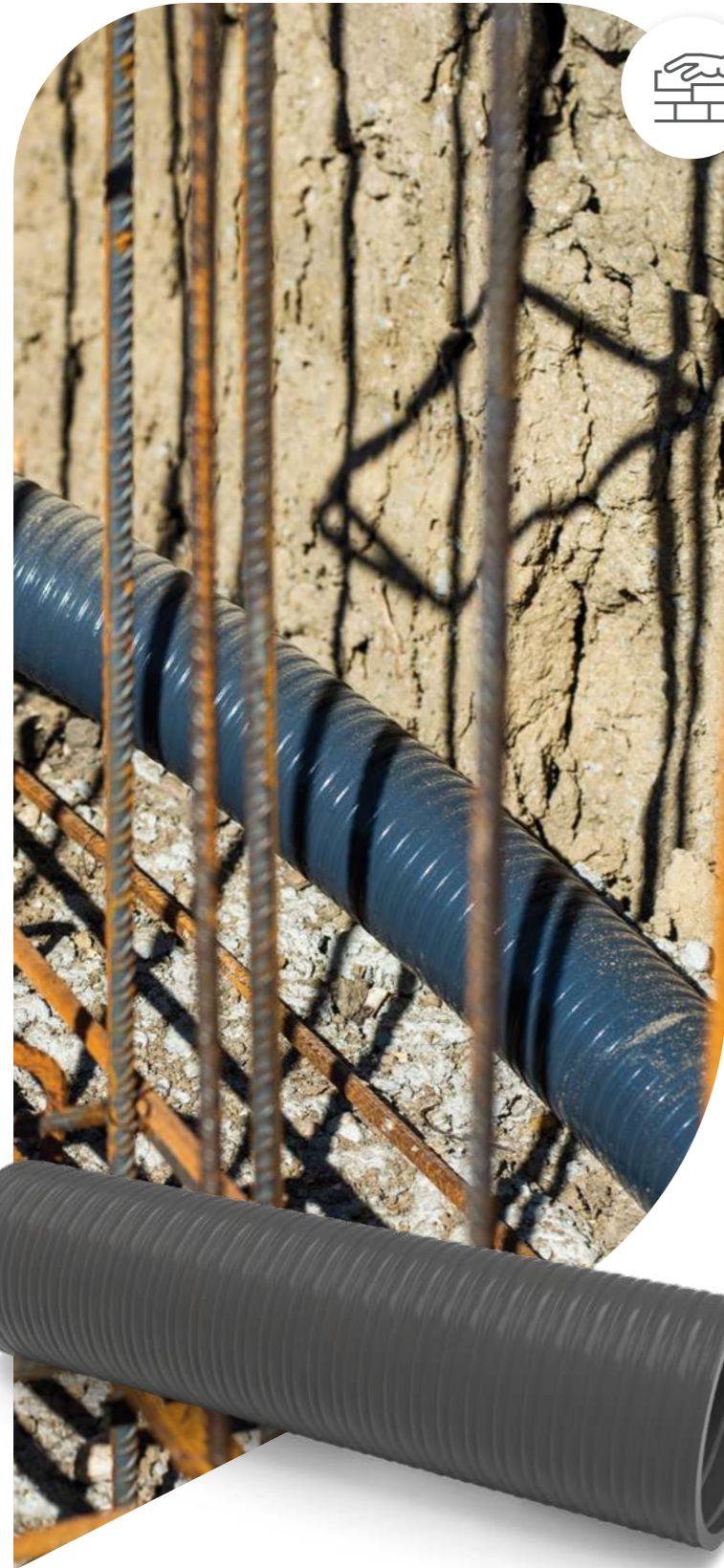

-10°C | +60°C TEMPERATURE RANGE
 SMOOTH INSIDE
 LOW CORRUGATION

EN This hose can be used for suction and delivery of fresh and sea water, sewage, fertilizers, chemical solutions, abrasive solids and slurries etc.

FR Ce tuyau peut être utilisé pour l'aspiration et le refoulement d'eau douce et d'eau de mer, des eaux usées, des engrais, solutions chimiques, solides abrasifs et bouillies etc.

ES Esta manguera se puede utilizar para succión y entrega. De agua dulce y de mar, aguas residuales, fertilizantes, soluciones químicas, sólidos abrasivos y lodos etc.

DE Dieser Schlauch kann zum Saugen und Ausgeben verwendet werden von Süß- und Meerwasser, Abwasser, Düngemitteln, chemische Lösungen, abrasive Feststoffe u Schlämme usw.

RU Этот шланг можно использовать для всасывания и нагнетания пресной и морской воды, сточных вод, удобрений, химические растворы, абразивные твердые вещества и суспензии и т. д.

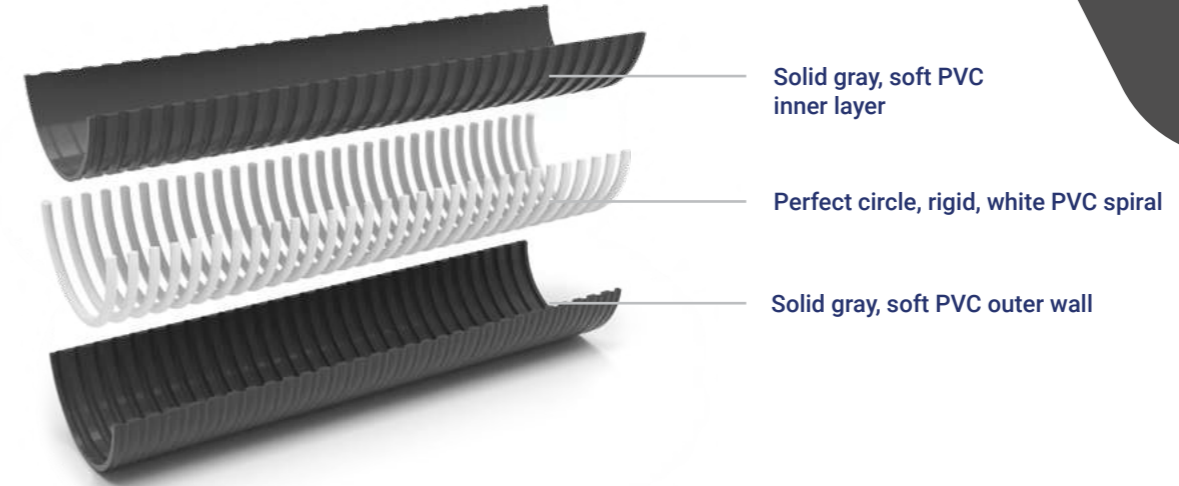

code	inch	mm	gr/m	bar	mbar	mm	m
F021N019	3/4	19	415	7	950	114	25/30/50
F021N020		20	425	7	950	120	25/30/50
F021N025	1	25	555	7	950	150	25/30/50
F021N030		30	630	6	950	180	25/30/50
F021N032	1 1/4	32	680	6	950	192	25/30/50
F021N035		35	730	5	950	210	25/30/50
F021N038	1 1/2	38	775	5	950	228	25/30/50
F021N040		40	825	5	950	240	25/30/50
F021N045	1 3/4	45	970	5	950	270	25/30/50
F021N051	2	51	1165	5	950	300	25/30/50
F021N055		55	1360	5	950	330	25/30/50
F021N060		60	1550	5	950	360	25/30/50
F021N063	2 1/2	63	1700	5	950	378	25/30/50
F021N070	2 3/4	70	1845	4	950	420	25/30/50
F021N076	3	76	1940	4	950	450	25/30/50
F021N080		80	2135	4	950	480	25/30/50
F021N090	3 1/2	90	2425	4	950	540	25
F021N102	4	102	3200	4	950	600	25
F021N110	4 1/4	110	3590	4	950	660	25
F021N120		120	3880	3	900	720	25
F021N127	5	127	4075	3	900	750	25
F021N152	6	152	6110	3	900	900	25

* Working and bursting pressure valid at 20°C / Pression de fonctionnement et limite, à 20 ° C / Presión de trabajo y estallido válida a 20°C / Betriebsdruck und Berstdruck gültig bei 20°C / Рабочее давление и разрывное давление, при 20°C
 ** Length tolerance +/- 5% / Tolérance de longueur +/- 5% / Tolerancia de longitud +/- 5% / Längentoleranz +/- 5% / Допуск длины +/- 5%
 *** Inner Diameter tolerance +/- 2% / Tolérance de diamètre interne +/- 2% / Tolerancia del diámetro interno +/- 2% / Toleranz des inneren Durchmessers +/- 2% / Допуск внутреннего диаметра +/- 2%

- Other colors are available against MOQ
- Autres couleurs et longueurs sont disponibles avec la quantité minimale d'un ordre
- Se ofrecen otros colores y longitudes contra una cantidad mínima de pedido
- Andere Farben sind gegen Mindestbestellmenge erhältlich
- В другом цвете возможен при соблюдении минимальных количеств к заказу

032N Oil Resistant Suction & Delivery Hose



FR Tuyau d'aspiration et de transport résistant à l'huile
ES Manguera de succión y entrega resistente al aceite
DE Ölbeständiger Saug- und Förderschlauch
RU Маслостойчивый Напорно-всасывающий шланг



- 20°C | +60°C**
TEMPERATURE RANGE
- HIGH FLEXIBILITY**
- SMOOTH INSIDE**
- LOW CORRUGATION**

EN This hose can be used for suction and delivery of petroleum and petroleum products except for high aromatic content fuels. It is suitable for fuel, diesel, paraffin, hydraulic fluids and non-edible oils.

FR Ce tuyau peut être utilisé comme un tuyau d'aspiration et de transport pour pétrole et produits pétroliers sauf combustibles à haute teneur en composés aromatiques. Il convient aux carburants, au diesel, à la paraffine, aux fluides hydrauliques et aux huiles non comestibles.

ES Esta manguera se puede utilizar para la succión y la entrega de petróleo y productos derivados del petróleo, a excepción de los combustibles de alto contenido aromático. Es adecuado para combustible, diesel, parafina, fluidos hidráulicos y aceites no comestibles.

DE Dieser Schlauch kann zum Absaugen und Fördern von Erdöl und Erdölprodukten verwendet werden, mit Ausnahme von Kraftstoffen mit hohem Aromagehalt. Es eignet sich für Kraftstoffe, Diesel, Paraffin, Hydraulikflüssigkeiten und nicht essbare Öle.

RU Этот шланг можно использовать для всасывания и транспортировки нефти и нефтепродуктов, исключая горючее с сильно выраженными ароматизированными составляющими. Он подходит для бензина, дизеля, парафина, гидравлических жидкостей и непищевых масел.

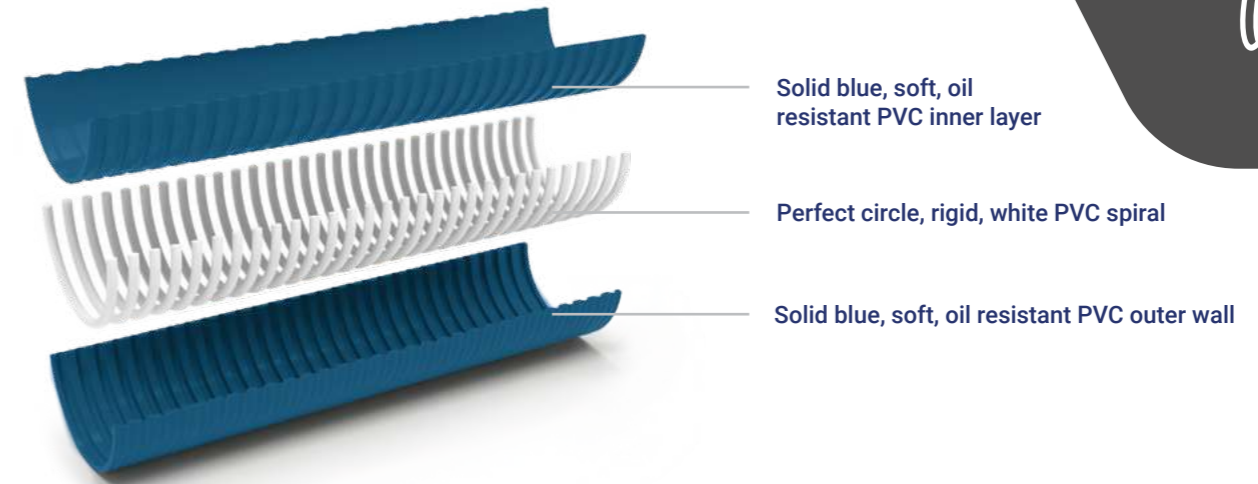

code	inch	mm	gr/m	bar	mbar	mm	m
F032N019	3/4	19	405	6	950	86	25/30/50
F032N020		20	405	6	950	91	25/30/50
F032N025	1	25	535	6	950	100	25/30/50
F032N030		30	630	5	950	112	25/30/50
F032N032	1 1/4	32	680	5	950	122	25/30/50
F032N035		35	730	5	950	130	25/30/50
F032N038	1 1/2	38	775	4,5	950	140	25/30/50
F032N040		40	825	4,5	950	148	25/30/50
F032N045	1 3/4	45	970	4,5	950	170	25/30/50
F032N051	2	51	1165	4,5	950	186	25/30/50
F032N055		55	1360	4,5	950	206	25/30/50
F032N060		60	1550	4,5	950	225	25/30/50
F032N063	2 1/2	63	1700	4,5	950	238	25/30/50
F032N070		70	1845	4	950	270	25/30/50
F032N076	3	76	1940	4	950	286	25/30/50
F032N080		80	2135	3,5	950	325	25
F032N090	3 1/2	90	2425	3,5	950	355	25
F032N102	4	102	3200	3	950	374	25
F032N110	4 1/4	110	3590	3	950	430	25
F032N120		120	3880	2,5	900	460	25
F032N127	5	127	4075	2,5	900	495	25
F032N152	6	152	6110	2,5	900	614	25

* Working and bursting pressure valid at 20°C / Pression de fonctionnement et limite, à 20 ° C / Presión de trabajo y estallido válida a 20°C / Betriebsdruck und Berstdruck gültig bei 20°C / Рабочее давление и разрывное давление, при 20°C / Längentoleranz +/- 5% / Допуск длины +/- 5%

** Length tolerance +/- 5% / Tolérance de longueur +/- 5% / Tolerancia de longitud +/- 5% / Längentoleranz +/- 5% / Допуск длины +/- 5%

*** Inner Diameter tolerance +/- 2% / Tolérance de diamètre interne +/- 2% / Tolerancia del diámetro interno +/- 2% / Toleranz des inneren Durchmessers +/- 2% / Допуск внутреннего диаметра +/- 2%



• Other colors are available against MOQ
 • Autres couleurs et longueurs sont disponibles avec la quantité minimale d'un ordre
 • Se ofrecen otros colores y longitudes contra una cantidad mínima de pedido
 • Andere Farben sind gegen Mindestbestellmenge erhältlich
 • В другом цвете возможен при соблюдении минимальных количеств к заказу

180G Poolflex Heavy Duty

FR Poolflex Heavy Duty
 ES Poolflex Heavy Duty
 DE Poolflex Heavy Duty
 RU Poolflex Heavy Duty

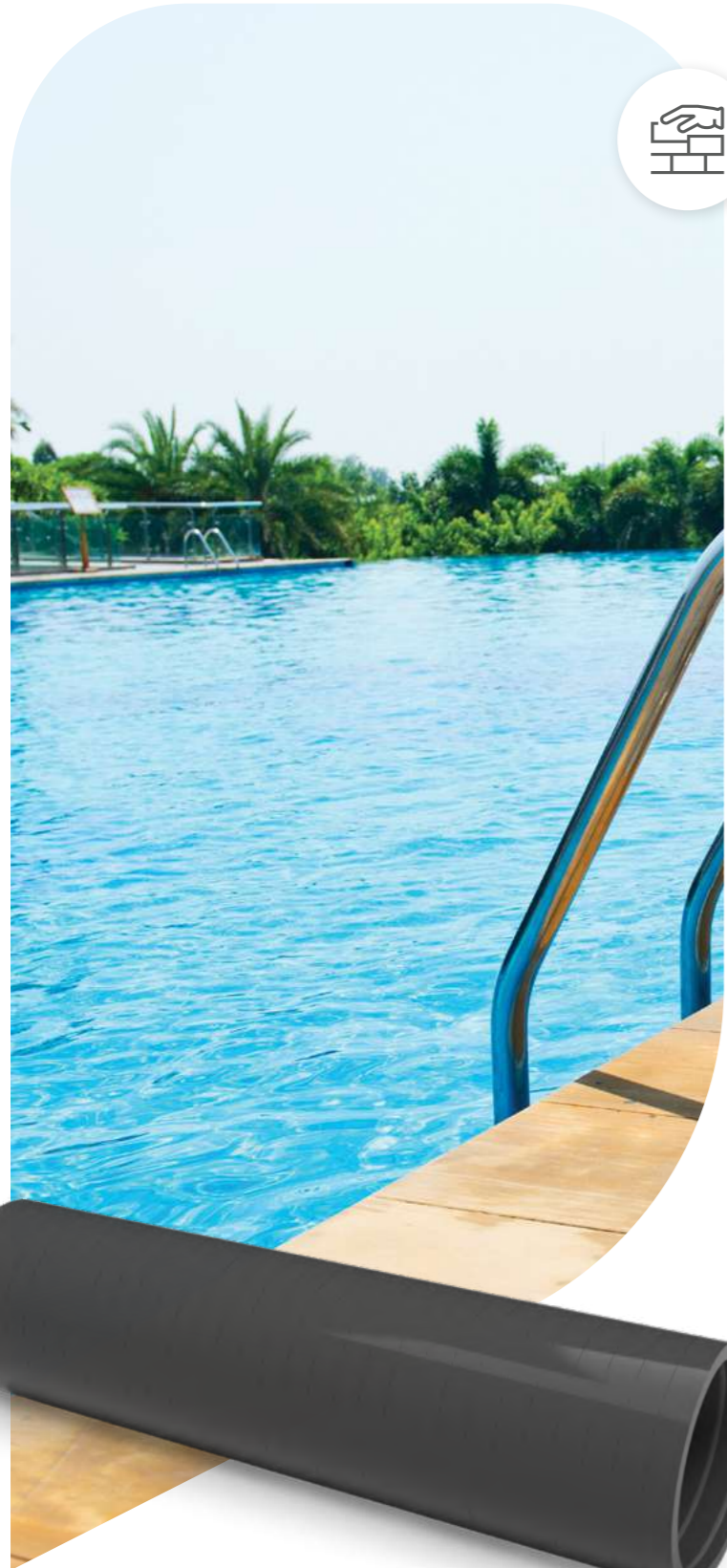

- 10°C | +60°C**
TEMPERATURE RANGE
- LOW**
CORRUIGATION
- EASY TO STORE**
AND INSTALL
- SMOOTH**
INSIDE
- SMOOTH**
OUTSIDE

EN This hose can be used for cost efficient water supply and recirculation in swimming pools.

FR Ce tuyau peut être utilisé comme un moyen efficace d'approvisionnement en eau et de recirculation dans les piscines.

ES Esta manguera se puede usar para el suministro de agua rentable y recirculación en piscinas.

DE Dieser Schlauch kann zur kostengünstigen Wasserversorgung und Rezirkulation in Schwimmbädern eingesetzt werden.

RU Этот шланг можно использовать как эффективное средство для подачи воды и рециркуляции в плавательных бассейнах.

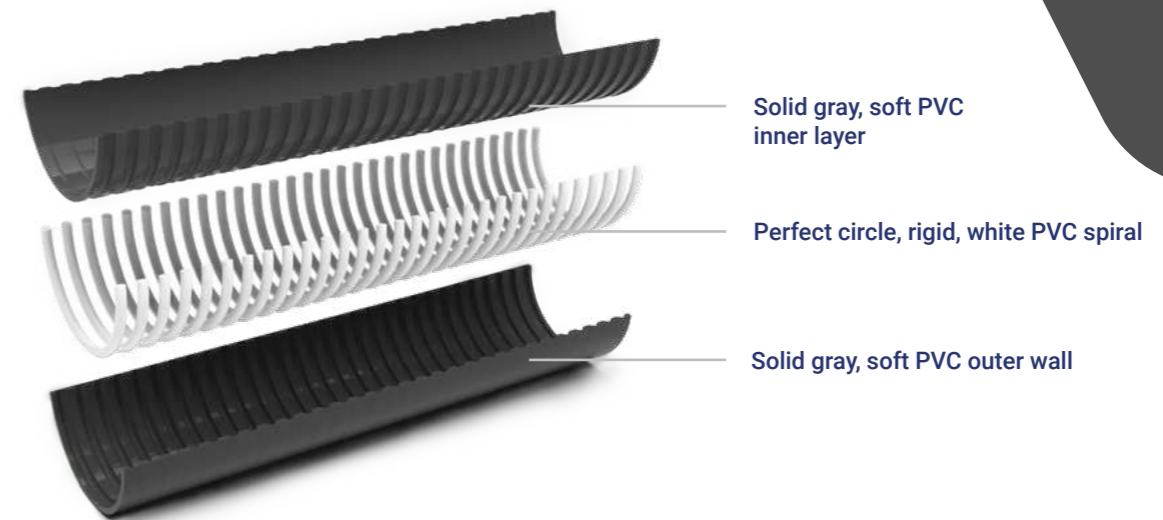

code	mm	mm	gr/m	23°C	43°C	mbar	mm	m
F180G020	20	16	180	8	5	800	75	25/30/50
F180G025	25	19	250	8	5	800	95	25/30/50
F180G032	32	25	380	8	5	800	125	25/30/50
F180G040	40	34	520	8	5	800	165	25/30/50
F180G050	50	43	725	6	4	800	215	25/30/50
F180G063	63	55	970	5	3	750	300	25/30/50
F180G075	75	67	1280	4	2	750	400	25/30/50
F180G090	90	80	1800	3	1,5	750	520	25/30/50

* **Working and bursting pressure valid at 20°C** / Pression de fonctionnement et limite, à 20 ° C / Presión de trabajo y estallido válida a 20°C / Betriebsdruck und Berstdruck gültig bei 20°C / Рабочее давление и разрывное давление, при 20°C
 ** **Length tolerance +/- 5%** / Tolérance de longueur +/- 5% / Tolerancia de longitud +/- 5% / Längentoleranz +/- 5% / Допуск длины +/- 5%
 *** **Inner Diameter tolerance +/- 2%** / Tolérance de diamètre interne +/- 2% / Tolerancia del diámetro interno +/- 2% Toleranz des inneren Durchmessers +/- 2% / Допуск внутреннего диаметра +/- 2%

- Other colors are available against MOQ
- Autres couleurs et longueurs sont disponibles avec la quantité minimale d'un ordre
- Se ofrecen otros colores y longitudes contra una cantidad mínima de pedido
- Andere Farben sind gegen Mindestbestellmenge erhältlich
- В другом цвете возможен при соблюдении минимальных количеств к заказу



181G Poolflex

FR Poolflex
 ES Poolflex
 DE Poolflex
 RU Poolflex



 -10°C | +60°C
 TEMPERATURE
 RANGE

 LOW
 CORRUGATION

 EASY TO STORE
 AND INSTALL

 SMOOTH
 INSIDE

 SMOOTH
 OUTSIDE

EN This hose can be used for cost efficient water supply and recirculation in swimming pools.

FR Ce tuyau peut être utilisé comme un moyen efficace d'approvisionnement en eau et de recirculation dans les piscines.

ES Esta manguera se puede usar para el suministro de agua rentable y recirculación en piscinas.

DE Dieser Schlauch kann zur kostengünstigen Wasserversorgung und Rezirkulation in Schwimmbädern eingesetzt werden.

RU Этот шланг можно использовать как эффективное средство для подачи воды и рециркуляции в плавательных бассейнах.

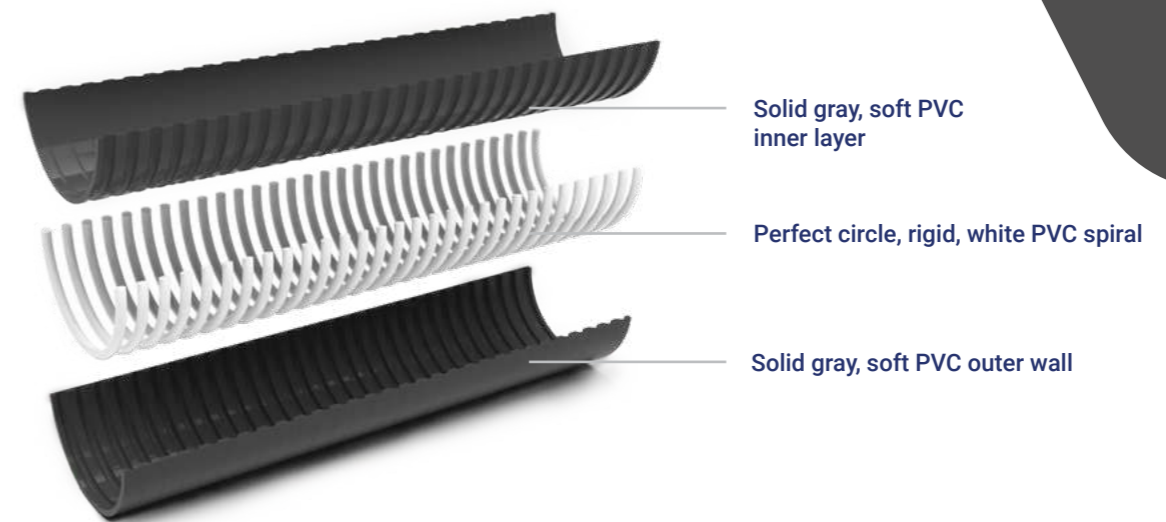

code	mm	mm	gr/m	23°C	43°C	mbar	mm	m
F181G020	20	16	160	8	5	800	75	25/50
F181G025	25	19	232	8	5	800	95	25/50
F181G032	32	25	320	8	5	800	125	25/50
F181G040	40	34	432	8	5	800	165	25/50
F181G050	50	43	672	6	4	800	215	25/50
F181G063	63	55	952	5	3	750	300	25/50

* **Working and bursting pressure valid at 20°C** / Pression de fonctionnement et limite, à 20 ° C / Presión de trabajo y estallido válida a 20°C / Betriebsdruck und Berstdruck gültig bei 20°C / Рабочее давление и разрывное давление, при 20°C
 ** **Length tolerance +/- 5%** / Tolérance de longueur +/- 5% / Tolerancia de longitud +/- 5% / Längentoleranz +/- 5% / Допуск длины +/- 5%
 *** **Inner Diameter tolerance +/- 2%** / Tolérance de diamètre interne +/- 2% / Tolerancia del diámetro interno +/- 2% Toleranz des inneren Durchmessers +/- 2% / Допуск внутреннего диаметра +/- 2%

 • Other colors are available against MOQ
 • Autres couleurs et longueurs sont disponibles avec la quantité minimale d'un ordre
 • Se ofrecen otros colores y longitudes contra una cantidad mínima de pedido
 • Andere Farben sind gegen Mindestbestellmenge erhältlich
 • В другом цвете возможен при соблюдении минимальных количеств к заказу



170M Pond Hose

- FR Tuyau pour eau contaminée
- ES Manguera de estanque
- DE Teichschlauch
- RU Сливной шланг

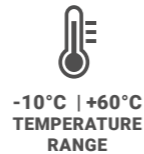

EN This hose can be used for:
 1. Water supply for artificial ponds and fountains
 2. Heavy duty cable sheathing and protection

FR Ce tuyau peut être utilisé pour:
 1. Approvisionnement en eau des lacs artificiels et des fontaines.
 2. Comme un revêtement et une protection des câbles dans des conditions difficiles

ES Esta manguera se puede usar para:
 1. Suministro de agua para estanques artificiales y fuentes.
 2. Revestimiento y protección de cables de alta resistencia

DE Dieser Schlauch kann verwendet werden als:
 1. Wasserversorgung für künstliche Teiche und Springbrunnen
 2. Hochbelastbare Kabelummantelung und-schutz

RU Области применения шланга:
 1. Подачи воды в искусственные пруды и фонтаны
 2. Как покрытие и средство защиты кабелей в тяжелых условиях работы

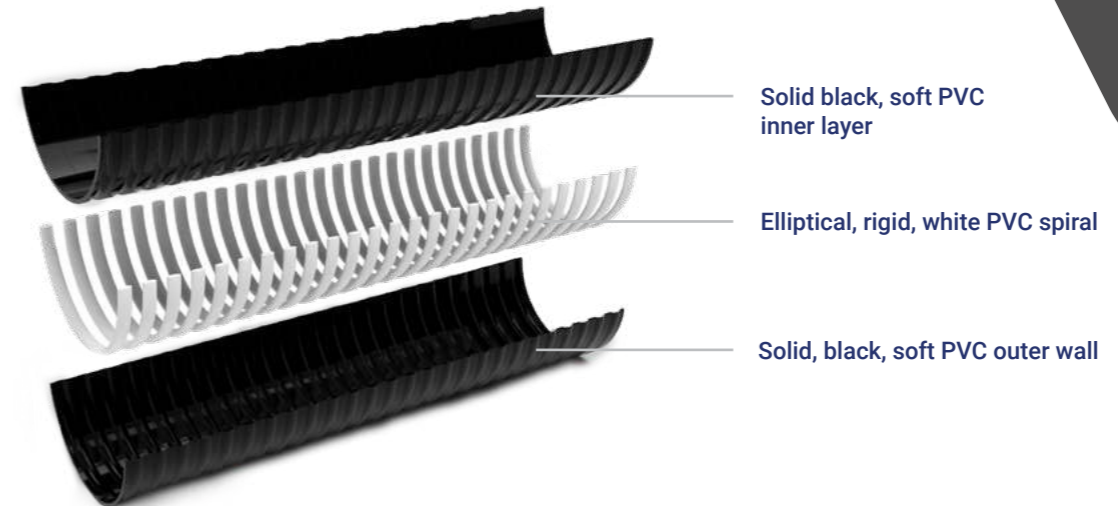

code	inch	mm	gr/m	bar	mbar	mm	m
F170M010		10	110	9	700	54	25/30/50
F170M013	1/2	13	125	9	700	54	25/30/50
F170M016	5/8	16	160	9	700	72	25/30/50
F170M019	3/4	19	200	8	700	85	25/30/50
F170M025	1	25	300	7	700	113	25/30/50
F170M032	1 1/4	32	340	6	700	144	25/30/50
F170M035		35	390	6	700	144	25/30/50
F170M038	1 1/2	38	420	6	700	171	25/30/50
F170M040		40	460	5,5	700	180	25/30/50
F170M045	1 3/4	45	530	5	700	202	25/30/50
F170M050	2	50	800	5	700	225	25/30/50
F170M051	2	51	800	5	700	225	25/30/50
F170M063	2 1/2	63	1050	4	700	250	25/30/50
F170M075	3	75	1250	4	700	275	25/30/50
F170M076	3	76	1250	4	700	275	25/30/50

- * **Working and bursting pressure valid at 20°C** / Pression de fonctionnement et limite, à 20°C / Presión de trabajo y estallido válida a 20°C / Betriebsdruck und Berstdruck gültig bei 20°C / Рабочее давление и разрывное давление, при 20°C
- ** **Length tolerance +/- 5%** / Tolérance de longueur +/- 5% / Tolerancia de longitud +/- 5% / Längentoleranz +/- 5% / Допуск длины +/- 5%
- *** **Inner Diameter tolerance +/- 2%** / Tolérance de diamètre interne +/- 2% / Tolerancia del diámetro interno +/- 2% / Toleranz des inneren Durchmessers +/- 2% / Допуск внутреннего диаметра +/- 2%

- Other colors are available against MOQ
- Autres couleurs et longueurs sont disponibles avec la quantité minimale d'un ordre
- Se ofrecen otros colores y longitudes contra una cantidad mínima de pedido
- Andere Farben sind gegen Mindestbestellmenge erhältlich
- В другом цвете возможен при соблюдении минимальных количеств к заказу





Food Quality

Qualité Alimentaire | Calidad Alimentaria
Lebensmittelqualität | Качества питания

007N Food Quality Suction & Delivery Hose

FR Tuyau d'aspiration et de transport adapté à l'industrie alimentaire
ES Manguera de succión y entrega apta para la industria alimentaria
DE Saug- und Förderschlauch in Lebensmittelqualität
RU Пищевой напорно-всасывающий шланг ПВХ



-10°C | +60°C
TEMPERATURE RANGE

FOOD QUALITY
10/2011 A, B, C, D1

EN This hose can be used for suction and delivery of water and other liquids in Agriculture or Food Industry.

FR Ce tuyau peut être utilisé comme un tuyau d'aspiration et de transport pour eau et d'autres liquides dans l'agriculture et Industrie alimentaire.

ES Dieser Schlauch kann zum Ansaugen und Fördern von Wasser und anderen Flüssigkeiten in der Landwirtschaft oder im Nahrungsmittelindustrie.

DE Esta manguera se puede utilizar para la succión y la entrega de agua y otros líquidos en la agricultura o la industria alimentaria.

RU Этот шланг можно использовать для всасывания и транспортировки воды и других жидкостей в сельском хозяйстве и пищевая промышленность.

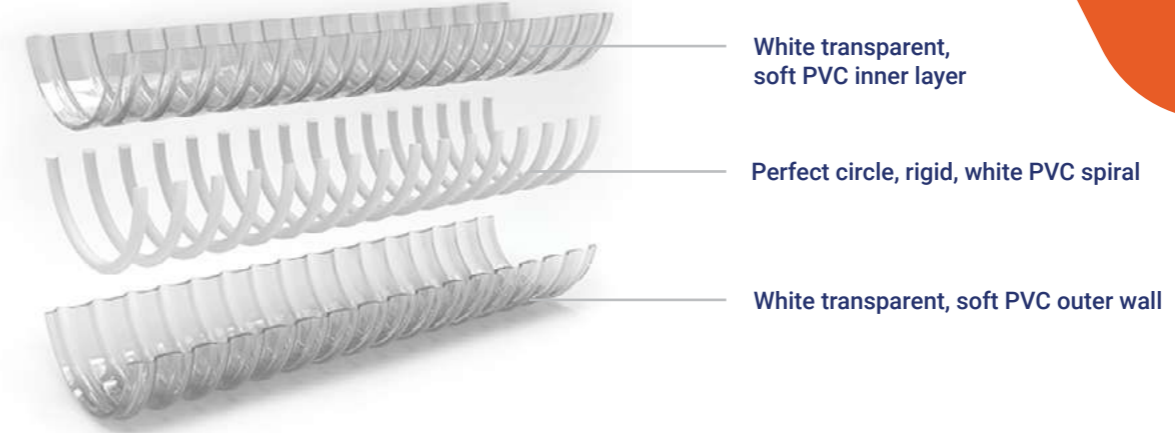

code	inch	mm	gr/m	bar	mbar	mm	m
F007N013	1/2	13	115	9	650	52	25/30/50
F007N016	5/8	16	145	9	650	64	25/30/50
F007N019	3/4	19	185	8	650	76	25/30/50
F007N020		20	195	8	650	80	25/30/50
F007N025	1	25	230	7	650	100	25/30/50
F007N030		30	280	7	650	120	25/30/50
F007N032	1 1/4	32	290	6	650	128	25/30/50
F007N035		35	440	6	650	140	25/30/50
F007N038	1 1/2	38	440	6	650	152	25/30/50
F007N040		40	520	5,5	650	160	25/30/50
F007N045	1 3/4	45	570	5	650	180	25/30/50
F007N051	2	51	690	5	650	200	25/30/50
F007N055		55	740	5	650	220	25/30/50
F007N060		60	800	5	650	240	25/30/50
F007N063	2 1/2	63	890	5	650	252	25/30/50
F007N070	2 3/4	70	1020	4	650	280	25/30/50
F007N076	3	76	1120	4	650	300	25/30/50
F007N080		80	1345	4	650	345	25/30/50
F007N090	3 1/2	90	1500	3	650	375	25
F007N102	4	102	1700	3	650	429	25

* Working and bursting pressure valid at 20°C / Pression de fonctionnement et limite, à 20°C / Pression de fonctionnement et limite, à 20 ° C / Betriebsdruck und Berstdruck gültig bei 20°C / Рабочее давление и разрывное давление, при 20°C

** Length tolerance +/- 5% / Tolérance de longueur +/- 5% / Tolerancia de longitud +/- 5% / Längentoleranz +/- 5% / Допуск длины +/- 5%

*** Inner Diameter tolerance +/- 2% / Tolérance de diamètre interne +/- 2% / Tolerancia del diámetro interno +/- 2% / Toleranz des inneren Durchmessers +/- 2% / Допуск внутреннего диаметра +/- 2%

Other colors are available against MOQ
 • Autres couleurs et longueurs sont disponibles avec la quantité minimale d'un ordre
 • Se ofrecen otros colores y longitudes contra una cantidad mínima de pedido
 • Andere Farben sind gegen Mindestbestellmenge erhältlich
 • В другом цвете возможен при соблюдении минимальных количеств к заказу



042NP Food Quality Suction & Delivery Hose



- FR** Tuyau d'aspiration et de transport adapté à l'industrie alimentaire
- ES** Manguera de succión y entrega apta para la industria alimentaria
- DE** Saug- und Förderschlauch in Lebensmittelqualität
- RU** Пищевой напорно-всасывающий шланг ПВХ



- 
-10°C | +60°C
TEMPERATURE RANGE
- 
HIGH FLEXIBILITY
- 
FOOD QUALITY
10/2011 A, B, C, D1

- EN** This hose can be used for suction and delivery of water, juice, beer, wine and other distillates up to 28°C alcohol.
- FR** Ce tuyau peut être utilisé comme un tuyau d'aspiration et de transport pour eau, jus, vin et d'autres distillats avec une teneur en alcool allant jusqu'à 28°.
- ES** Esta manguera se puede usar para aspirar y distribuir agua, jugos, vino y otros destilados de hasta 28° de alcohol.
- DE** Dieser Schlauch kann zum Ansaugen und Fördern von Wasser, Säften, Wein und anderen Destillaten bis 28°C Alkohol verwendet werden.
- RU** Этот шланг можно использовать для всасывания и транспортировки воды, соков, вина и других напитков с содержанием спирта до 28°C.

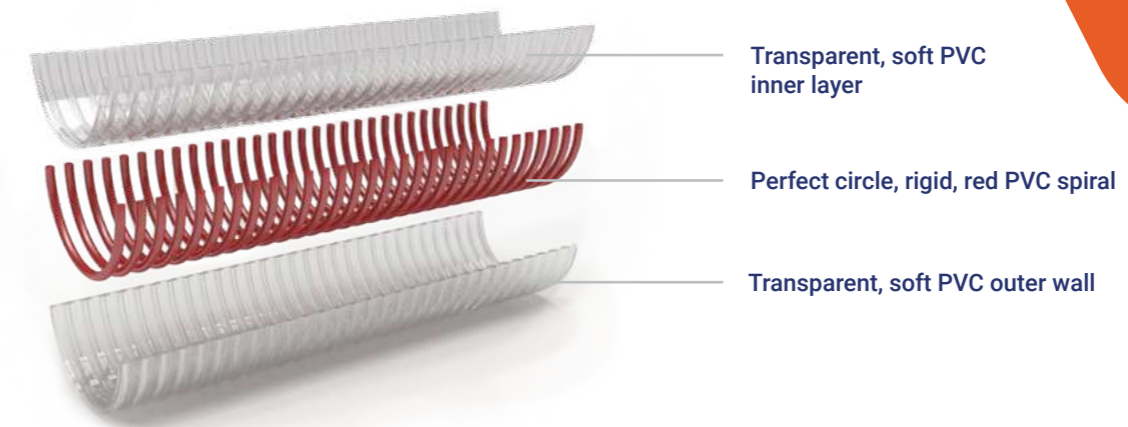

code	inch	mm	gr/m	bar	mbar	mm	m
F042NP019	3/4	19	335	8	900	95	25/30/50
F042NP020		20	335	7	900	100	25/30/50
F042NP025	1	25	400	6	900	125	25/30/50
F042NP030		30	535	6	900	150	25/30/50
F042NP032	1 1/4	32	580	6	900	160	25/30/50
F042NP038	1 1/2	38	680	6	900	190	25/30/50
F042NP040		40	710	6	900	200	25/30/50
F042NP045	1 3/4	45	815	6	900	225	25/30/50
F042NP051	2	51	970	5	900	250	25/30/50
F042NP055		55	1065	5	900	275	25/30/50
F042NP060		60	1240	5	900	300	25/30/50
F042NP063	2 1/2	63	1405	4,5	800	315	25/30/50
F042NP070	2 3/4	70	1550	4,5	800	350	25/30/50
F042NP076	3	76	1680	4,5	800	375	25/30/50
F042NP080		80	1795	4,5	800	400	25/30/50
F042NP090	3 1/2	90	2055	4	800	450	25
F042NP102	4	102	2600	3	800	500	25
F042NP110	4 1/2	110	2910	3	800	550	25
F042NP120		127	3200	3	800	600	25
F042NP127	5	127	3395	3	800	625	25
F042NP152	6	152	4460	2	800	750	25

* **Working and bursting pressure valid at 20°C** / PPression de fonctionnement et limite, à 20 ° C / Presión de trabajo y estallido válida a 20°C / Betriebsdruck und Berstdruck gültig bei 20°C / Рабочее давление и разрывное давление, при 20°C

** **Length tolerance +/- 5%** / Tolérance de longueur +/- 5% / Tolerancia de longitud +/- 5% / Längentoleranz +/- 5% / Допуск длины +/- 5%

*** **Inner Diameter tolerance +/- 2%** / Tolérance de diamètre interne +/- 2% / Tolerancia del diámetro interno +/- 2% / Toleranz des inneren Durchmessers +/- 2% / Допуск внутреннего диаметра +/- 2%

Other colors are available against MOQ
 Autres couleurs et longueurs sont disponibles avec la quantité minimale d'un ordre
 Se ofrecen otros colores y longitudes contra una cantidad mínima de pedido
 Andere Farben sind gegen Mindestbestellmenge erhältlich
 В другом цвете возможен при соблюдении минимальных количеств к заказу



022NP Food Quality Suction & Delivery Hose



FR Tuyau d'aspiration et de transport adapté à l'industrie alimentaire
ES Manguera de succión y entrega apta para la industria alimentaria
DE Saug- und Förderschlauch in Lebensmittelqualität
RU Пищевой напорно-всасывающий шланг ПВХ



 **-10°C | +60°C**
TEMPERATURE RANGE

 **SMOOTH INSIDE**

 **FOOD QUALITY**
10/2011 A, B, C, D1

EN This hose can be used for suction and delivery of water, juice, beer, wine and other distillates up to 28°C alcohol.

FR Ce tuyau peut être utilisé comme un tuyau d'aspiration et de transport pour eau, jus, vin et d'autres distillats avec une teneur en alcool allant jusqu'à 28°.

ES Esta manguera se puede usar para aspirar y distribuir agua, jugos, vino y otros destilados de hasta 28° de alcohol.

DE Dieser Schlauch kann zum Ansaugen und Fördern von Wasser, Säften, Wein und anderen Destillaten bis 28°C Alkohol verwendet werden.

RU Этот шланг можно использовать для всасывания и транспортировки воды, соков, вина и других напитков с содержанием спирта до 28°C.

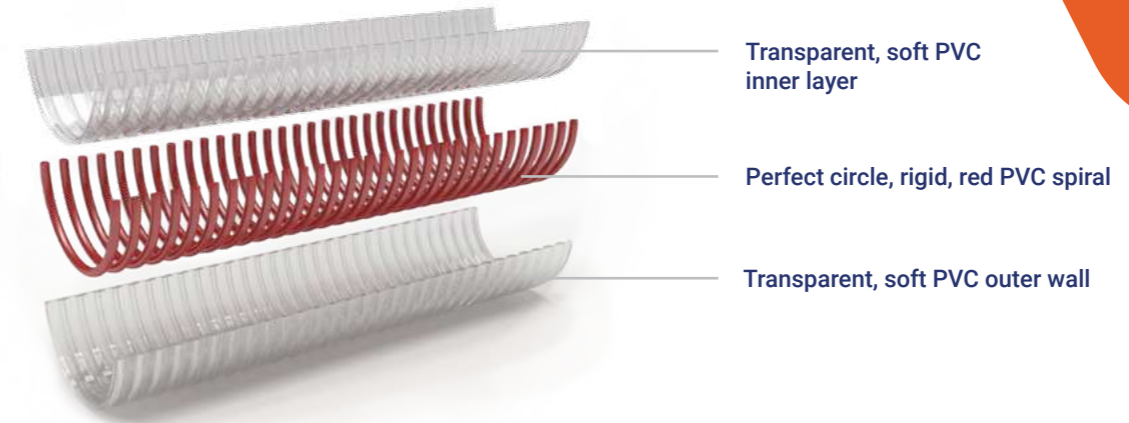

code	inch	mm	gr/m	bar	mbar	mm	m
F022NP019	3/4	19	415	7	950	114	25/30/50
F022NP020		20	415	7	950	120	25/30/50
F022NP025	1	25	555	7	950	150	25/30/50
F022NP030		30	630	6	950	180	25/30/50
F022NP032	1 1/4	32	680	6	950	192	25/30/50
F022NP035		35	730	5	950	210	25/30/50
F022NP038	1 1/2	38	775	5	950	228	25/30/50
F022NP040		40	825	5	950	240	25/30/50
F022NP045	1 3/4	45	970	5	950	270	25/30/50
F022NP051	2	51	1165	5	950	300	25/30/50
F022NP055		55	1360	5	950	330	25/30/50
F022NP060		60	1550	5	950	360	25/30/50
F022NP063	2 1/2	63	1700	5	950	378	25/30/50
F022NP067		67	1770	4	950	400	25/30/50
F022NP070	2 3/4	70	1845	4	950	420	25/30/50
F022NP076	3	76	1940	4	950	450	25/30/50
F022NP080	3	80	2135	4	950	480	25/30/50
F022NP090	3 1/2	90	2425	4	950	540	25
F022NP102	4	102	3200	3,5	950	600	25
F022NP110	4 1/2	110	3590	3,5	900	660	25
F022NP120		120	3880	3	900	720	25
F022NP127	5	127	4075	3	900	750	25
F022NP152	6	152	6100	3	900	900	25

* **Working and bursting pressure valid at 20°C** / PPression de fonctionnement et limite, à 20 ° C / Presión de trabajo y estallido válida a 20°C / Betriebsdruck und Berstdruck gültig bei 20°C / Рабочее давление и разрывное давление, при 20°C
 ** **Length tolerance +/- 5%** / Tolérance de longueur +/- 5% / Tolerancia de longitud +/- 5% / Längentoleranz +/- 5% / Допуск длины +/- 5%
 *** **Inner Diameter tolerance +/- 2%** / Tolérance de diamètre interne +/- 2% / Tolerancia del diámetro interno +/- 2% / Toleranz des inneren Durchmessers +/- 2% / Допуск внутреннего диаметра +/- 2%



 Other colors are available against MOQ
 • Autres couleurs et longueurs sont disponibles avec la quantité minimale d'un ordre
 • Se ofrecen otros colores y longitudes contra una cantidad mínima de pedido
 • Andere Farben sind gegen Mindestbestellmenge erhältlich
 • В другом цвете возможен при соблюдении минимальных количеств к заказу

320N Food Quality Clear Braided Hose



FR Tuyau transparent tressé adapté à l'industrie alimentaire
ES Manguera trenzada clara apta para la industria alimentaria
DE Transparenter Geflechschlauch in Lebensmittelqualität
RU Пищевой оплетенно-напорный прозрачный шланг ПВХ

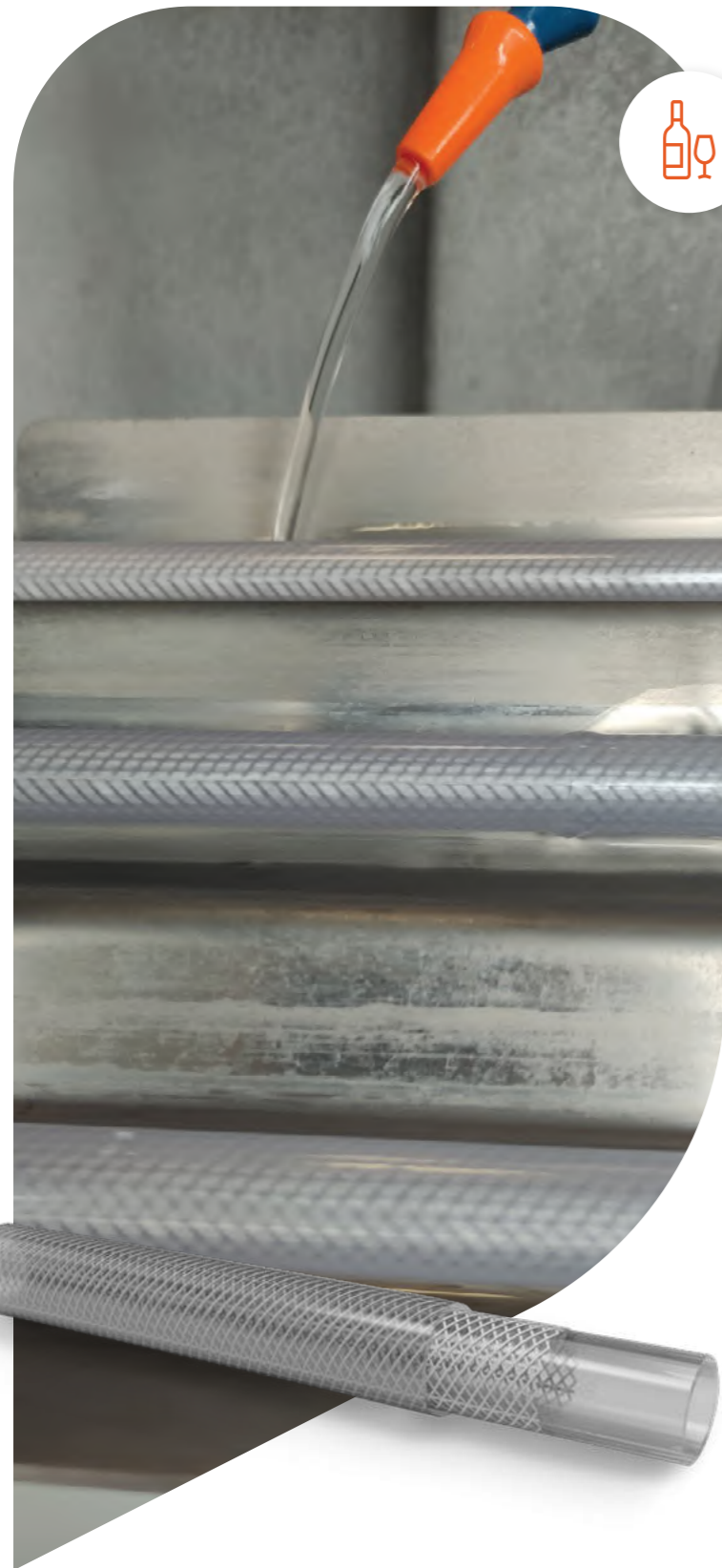

-10°C | +60°C
TEMPERATURE RANGE

FOOD QUALITY
10/2011 A, B, C, D1

EN This is a multipurpose hose used primarily for transfer of alimentary liquids.

FR C'est un tuyau multifonctionnel utilisé principalement pour le transport de liquides alimentaires.

ES Esta es una manguera multipropósito utilizada principalmente para la entregade líquidos alimentarios.

DE Es handelt sich um einen Mehrzweckschlauch, der vor allem für den Transport von Nahrungsfüssigkeiten verwendet wird.

RU Многофункциональный шланг, который используется преимущественно для переноса пищевых жидкостей.

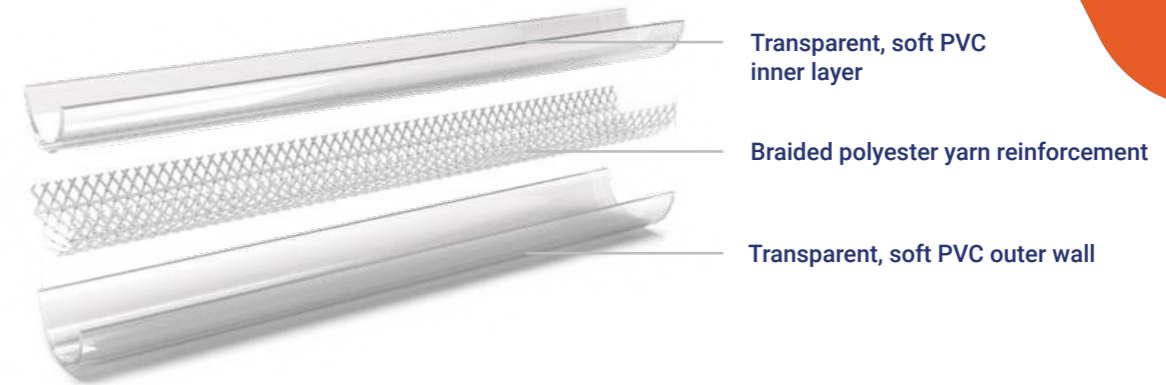

code	inch	mm	mm	gr/m	bar	bar	m
V320N00611	1/4	6	11	80	25	75	25/50/100
V320N00612	1/4	6	12	105	25	75	25/50/100
V320N00614	1/4	6	14	145	25	75	25/50/100
V320N00713		7	13	115	25	75	25/50/100
V320N00813	5/16	8	13	105	25	75	25/50/100
V320N00814	5/16	8	14	125	25	75	25/50/100
V320N00817	5/16	8	17	220	25	75	25/50/100
V320N00914		9	14	125	20	60	25/50/100
V320N00915		9	15	135	20	60	25/50/100
V320N01015	3/8	10	15	120	20	60	25/50/100
V320N01016	3/8	10	16	150	20	60	25/50/100
V320N01217		12	17	130	20	60	25/50/100
V320N01218		12	18	180	20	60	25/50/100
V320N01318	1/2	13	18	150	13	40	25/50/100
V320N01319	1/2	13	19	175	15	45	25/50/100
V320N01521		15	21	215	11	32	25/50
V320N01523		15	23	280	11	32	25/50
V320N01621	5/8	16	21	185	11	32	25/50
V320N01622	5/8	16	22	210	11	32	25/50
V320N01925	3/4	19	25	260	10	30	25/50
V320N01926	3/4	19	26	300	10	30	25/50
V320N02230		22	30	320	9	27	25/50
V320N02532	1	25	32	390	8	24	25/50
V320N02533	1	25	33	450	8	24	25/50
V320N03241	1 1/4	32	41,5	650	7	22	25/50
V320N03848	1 1/2	38	48	860	7	20	25/50
V320N05161	2	51	61,5	1120	5	15	25/50

* Working and bursting pressure valid at 20°C / Pression de fonctionnement et limite, à 20° C / Presión de trabajo y estallido válida a 20°C / Betriebsdruck und Berstdruck gültig bei 20°C / Рабочее давление и разрывное давление, при 20°C

** Length tolerance +/- 5% / Tolérance de longueur +/- 5% / Tolerancia de longitud +/- 5% / Längentoleranz +/- 5% / Допуск длины +/- 5%

*** Inner Diameter tolerance +/- 2% / Tolérance de diamètre interne +/- 2% / Tolerancia del diámetro interno +/- 2% / Toleranz des inneren Durchmessers +/- 2% / Допуск внутреннего диаметра +/- 2%



• Other colors are available against MOQ
 • Autres couleurs et longueurs sont disponibles avec la quantité minimale d'un ordre
 • Se ofrecen otros colores y longitudes contra una cantidad mínima de pedido
 • Andere Farben sind gegen Mindestbestellmenge erhältlich
 • В другом цвете возможен при соблюдении минимальных количеств к заказу

501N Food Quality Suction & Delivery Hose

FR Tuyau d'aspiration et de transport adapté à l'industrie alimentaire
ES Manguera de succión y entrega apta para la industria alimentaria
DE Saug- und Förderschlauch in Lebensmittelqualität
RU Пищевой напорно-всасывающий шланг ПВХ



-10°C | +60°C
TEMPERATURE RANGE

SMOOTH INSIDE

LOW CORRUGATION

FOOD QUALITY 10/2011 A, B, C, D1

EN This hose can be used for suction and delivery of slurries, potable water, foodstuffs, distillates up to 28°C alcohol. Also as equipment for agricultural and industrial machineries.

FR Comme un tuyau d'aspiration et de transport pour suspensions, eau potable, produits alimentaires, distillats avec une teneur en alcool allant jusqu'à 28°, ainsi que comme un équipement pour machines agricoles et industrielles.

ES Esta manguera se puede usar para aspiración y entrega de lodos, agua potable, productos alimenticios, destilados de hasta 28 ° de alcohol. Además, como equipo para maquinarias agrícolas e industriales.

DE Dieser Schlauch kann zum Absaugen und Fördern von Schlämmen, Trinkwasser, Lebensmitteln, Destillaten bis 28°C Alkohol. Auch als Ausrüstung für landwirtschaftliche und industrielle Maschinen.

RU Этот шланг можно использовать для всасывания и транспортировки растворов, питьевой воды, пищевых веществ, напитков с содержанием спирта до 28°C. А также как расходный материал для сельскохозяйственной и промышленной техники.

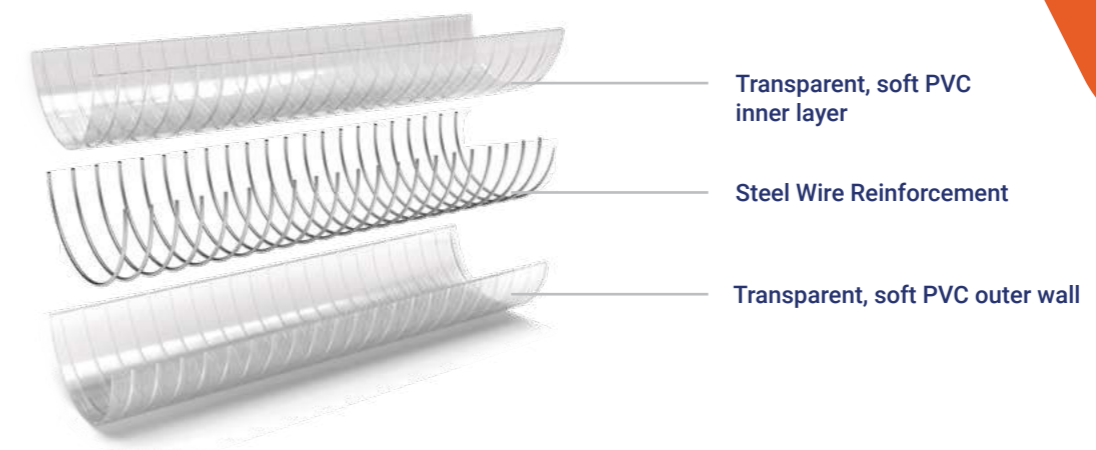

code	inch	mm	gr/m	bar	mbar	mm	m
S501N019	3/4	19	320	7	900	48	25/30/50
S501N025	1	25	510	6	900	63	25/30/50
S501N032	1 1/4	32	650	5	900	80	25/30/50
S501N038	1 1/2	38	800	5	900	228	25/30/50
S501N040		40	850	5	900	240	25/30/50
S501N051	2	51	1250	5	900	300	25/30/50
S501N063	2 1/2	63	1950	4	850	378	25/30
S501N076	3	76	2450	4	850	450	25/30
S501N102	4	102	3500	2,5	800	600	25/30

* **Working and bursting pressure valid at 20°C** / PPression de fonctionnement et limite, à 20 ° C / Presión de trabajo y estallido válida a 20°C / Betriebsdruck und Berstdruck gültig bei 20°C / Рабочее давление и разрывное давление, при 20°C

** **Length tolerance +/- 5%** / Tolérance de longueur +/- 5% / Tolerancia de longitud +/- 5% / Längentoleranz +/- 5% / Допуск длины +/- 5%

*** **Inner Diameter tolerance +/- 2%** / Tolérance de diamètre interne +/- 2% / Tolerancia del diámetro interno +/- 2% / Toleranz des inneren Durchmessers +/- 2% / Допуск внутреннего диаметра +/- 2%

• Other colors are available against MOQ
 • Autres couleurs et longueurs sont disponibles avec la quantité minimale d'un ordre
 • Se ofrecen otros colores y longitudes contra una cantidad mínima de pedido
 • Andere Farben sind gegen Mindestbestellmenge erhältlich
 • В другом цвете возможен при соблюдении минимальных количеств к заказу

REACH COMPLIANT **RoHS COMPLIANT** **ISO 1307:2006 CERTIFIED** **ISO 9001:2015 CERTIFIED**

600N Cristal Hose Food Quality

FR Tuyau en PVC souple de qualité alimentaire
 ES Manguera de PVC de calidad alimentaria
 DE Lebensmittelqualität PVC-Schlauch
 RU Шланг ПВХ для пищевой промышленности



-10°C | +60°C
TEMPERATURE
RANGE

FOOD
QUALITY
10/2011 A, B, C, D1

EN Soft PVC hose in single layer, for transporting liquids or air with industrial, pharmaceutical or food applications.

FR Tuyau en PVC souple en une seule couche, destiné au transport de liquides ou d'air dans des applications industrielles, pharmaceutiques ou alimentaires.

ES Manguera de PVC suave de una sola capa, diseñada para transportar líquidos o aire en aplicaciones industriales, farmacéuticas o alimentarias.

DE Weicher PVC-Schlauch in Einzelschicht, geeignet für den Transport von Flüssigkeiten oder Luft in industriellen, pharmazeutischen oder Lebensmittel-Anwendungen.

RU Мягкий ПВХ-шланг однослойной конструкции для транспортировки жидкостей или воздуха в промышленных, фармацевтических или пищевых приложениях.



Single layer of transparent soft PVC, not reinforced



code	mm	mm	gr/m	bar	bar	m
V600N00406	4	6	19	4	12	25/50/100
V600N00407	4	7	35	9	27	25/50/100
V600N00507	5	7	23	4	12	25/50/100
V600N00608	6	8	28	4	12	25/50/100
V600N00609	6	9	45	5	15	25/50/100
V600N00610	6	10	62	9	27	25/50/100
V600N00612	6	12	104	11	33	25/50/100
V600N00710	7	10	57	4	12	25/50/100
V600N00711	7	11	68	8	24	25/50/100
V600N00811	8	11	55	4	12	25/50/100
V600N00812	8	12	78	7	21	25/50/100
V600N00912	9	12	61	3	9	25/50/100
V600N00913	9	13	84	5	15	25/50/100
V600N01013	10	13	66	4	12	25/50/100
V600N01014	10	14	95	6	18	25/50/100
V600N01016	10	16	151	7	21	25/50/100
V600N01216	12	16	110	4	12	25/50/100
V600N01319	13	19	184	6	18	25/50/100
V600N01418	14	18	125	4	12	25/50/100
V600N01519	15	19	132	4	12	25/50/100
V600N01620	16	20	140	2,5	7,5	25/50/100
V600N01621	16	21	177	3	9	25/50/100
V600N01823	18	23	198	3	9	25/50/100
V600N01924	19	24	210	3	9	25/50/100
V600N01925	19	25	253	3	9	25/50/100
V600N02025	20	25	220	2,5	7,5	25/50/100
V600N02026	20	26	264	3	9	25/50/100
V600N02228	22	28	290	3	9	25/50/100
V600N02230	22	30	395	4	12	25/50/100
V600N02531	25	31	324	2,5	7,5	25/50/100
V600N02533	25	33	473	3,5	10,5	25/50/100

* Working and bursting pressure valid at 20°C / Pression de fonctionnement et limite, à 20° C / Presión de trabajo y estallido válida a 20°C / Betriebsdruck und Berstdruck gültig bei 20°C / Рабочее давление и разрывное давление, при 20°C

** Length tolerance +/- 5% / Tolérance de longueur +/- 5% / Tolerancia de longitud +/- 5% / Längentoleranz +/- 5% / Допуск длины +/- 5%

*** Inner Diameter tolerance +/- 2% / Tolérance de diamètre interne +/- 2% / Tolerancia del diámetro interno +/- 2% / Toleranz des inneren Durchmessers +/- 2% / Допуск внутреннего диаметра +/- 2%

• Other colors are available against MOQ
 • Autres couleurs et longueurs sont disponibles avec la quantité minimale d'un ordre
 • Se ofrecen otros colores y longitudes contra una cantidad mínima de pedido
 • Andere Farben sind gegen Mindestbestellmenge erhältlich
 • В другом цвете возможен при соблюдении минимальных количеств к заказу





W

Commercial Terms

FR CONDITIONS COMMERCIALES
ES TÉRMINOS COMERCIALES

DE GESCHÄFTSBEDINGUNGEN
RU КОММЕРЧЕСКИЕ УСЛОВИЯ

EN **A.** The orders placed by the DISTRIBUTOR are sent to, and the invoices are issued by Plexistab Bulgaria EAD, 53 Tsarigradsko shose Blvd., Plovdiv City

B. Unless otherwise agreed in writing, all Products are loaded and invoiced under the ExW Plovdiv commercial terms, which include packing.

C. All payments are made be in Euros.

D. All payments for the Products are made to the bank account of Plexistab Bulgaria EAD and to an address specially indicated on the invoice for each separate delivery under the agreed terms of payment:

E. The SUPPLIER reserves its right to refuse to fulfill any order if the credit limit has been exceeded.

F. The SUPPLIER reserves its right to refuse to fulfill any order if the following limit of late payments has been exceeded:

G. The goods are transferred under the INCOTERMS / International Commercial Terms /

H. The price lists for the Products are updated every six months and submitted to the DISTRIBUTOR in writing, not later than within 20 calendar days before the beginning of the new period. The delivery will be fulfilled in accordance with the price list conditions for the preceding period only if the order has been placed throughout the validity period of the price list and the delivery has been confirmed by the DISTRIBUTOR in writing, not later than within one month from the end of the validity period of the price list according to which the order has been placed.

The schedules of the forecast sales of the SUPPLIER guarantee the time of delivery but do not guarantee the price. The price is fixed according to the price list of the SUPPLIER (on a quarterly basis)

I. Complaints

1. The DISTRIBUTOR is obliged to notify the SUPPLIER of any product quality complaints regarding the Products offered by the latter, in writing, no later than within 3 days from the date on which the DISTRIBUTOR's customer has lodged such complaint. Complaints are valid only if lodged in writing, as such written form is also obligatory for DISTRIBUTOR's customers. Each complaint must be accompanied by photographs of the Product for which the complaint has been lodged, as they must provide evidence of the cause of the complaint and the production code of the product. Complaints for Products whose production code is not clearly visible will not be dealt with by the SUPPLIER.

2. The DISTRIBUTOR is obliged to notify the SUPPLIER without delay – not later than within 3 hours form delivery unloading – of any non-compliance of the packing and quantity of the delivered Products. The DISTRIBUTOR is obliged to record the shortages, damaged packing and damage during transportation on the CMR (consignment note), accompanying the shipment. Otherwise, the SUPPLIER bears no responsibility for damage caused due to shortages, damaged packing and/ or damage during transportation.

FR **A.** Les commandes faites par le DISTRIBUTEUR sont envoyées à et les factures sont émises par Plexistab Bulgarie EAD, 53 boul.Tsarigradsko shose, Plovdiv.

B. Sauf convention écrite contraire, tous les Produits sont chargés et facturés conformément aux conditions commerciales d'ExW Plovdiv, qui inclut un emballage.

C. Tous les paiements sont effectués en euros.

D. Tous les paiements pour les Produits doivent être effectués sur un compte bancaire de PlexiStab Bulgaria EAD et à l'adresse indiquée sur la facture pour chaque livraison individuelle selon les conditions de paiement convenues.

E. Le FOURNISSEUR se réserve le droit de refuser d'exécuter toute livraison si la limite de crédit est dépassée:

F. Le FOURNISSEUR se réserve le droit de refuser d'exécuter toute livraison si la prochaine limite des paiements en retard est dépassée.

G. Les marchandises sont remises conformément aux conditions commerciales internationales INCOTERMS

H. La liste des prix pour les produits est mise à jour tous les six mois et envoyée par écrit au DISTRIBUTEUR au plus tard 20 jours civils avant le début de la nouvelle période. La livraison sera exécutée conformément aux termes de la liste des prix pour la période précédente uniquement si la commande est faite au cours de la période de validité de la liste des prix et la livraison est confirmée par écrit par le DISTRIBUTEUR au plus tard un mois après la fin de la durée de validité de la liste des prix selon laquelle la commande a été faite.

Le calendrier de ventes prévisionnelles du FOURNISSEUR garantit le délai de livraison, mais ne garantit pas un prix. Le prix est fixé en fonction de la liste des prix du FOURNISSEUR (sur une base trimestrielle).

I. Réclamations

1. Le DISTRIBUTEUR est tenu d'aviser le FOURNISSEUR pour toute réclamation liée à la qualité des produits offerts par ce dernier, par écrit au plus tard trois jours après la date à laquelle le client du DISTRIBUTEUR a présenté une telle réclamation. Les réclamations ne sont valables que si elles sont faites par écrit, et ce formulaire écrit est également obligatoire pour les clients du DISTRIBUTEUR. Chaque réclamation doit être accompagnée de photos du produit, pour lequel elle est faite, et elles doivent fournir une preuve de la raison de la réclamation et le code de production du produit. Les réclamations pour les Produits dont le code de production n'est pas clairement visible ne seront pas traitées par le FOURNISSEUR.

2. Le DISTRIBUTEUR est obligé d'informer le FOURNISSEUR immédiatement - au plus tard 3 heures après le déchargement de la livraison pour toute non-conformité à l'emballage et la qualité des produits livrés. Le DISTRIBUTEUR est obligé de noter des manques, dommages à l'emballage et des dommages de transport sur le CMR (connaissance), accompagnant l'expédition. Dans le cas contraire, le FOURNISSEUR décline toute responsabilité en cas de dommages dus à un manque, à un emballage endommagé ou à des dommages subis pendant le transport.

ES **A.** Los pedidos realizados por el DISTRIBUIDOR se envían a, y las facturas son emitidas por Plexistab Bulgaria EAD, 53 Tsarigradsko shose Blvd., Plovdiv City

B. A menos que se acuerde lo contrario por escrito, todos los productos se cargan y facturan según los términos comerciales de ExW Plovdiv, que incluyen el embalaje.

C. Todos los pagos se realizan en Euros.

D. Todos los pagos paralos Productos se realizan en la cuenta bancaria de Plexistab Bulgaria EAD y en una dirección especialmente indicada en la factura para cada entrega por separado según las condiciones de pago acordadas:

E. El PROVEEDOR se reserva el derecho de negarse a cumplir cualquier pedidosi se ha excedido el límite de crédito:

F. El PROVEEDOR se reserva el derecho de negarse a cumplir cualquier pedido si se supera el siguiente límite de pagos atrasados.

G. Los bienes son transferidos segúnINCOTERMS / Términos Comerciales Internacionales /

H. Las listas de precios de los Productos se actualizan cada seis meses y se envían al DISTRIBUIDOR por escrito, a más tardar 20 días naturales antes del comienzo del nuevo período. La entrega se realizará de acuerdo con las condiciones de la lista de precios para el período anterior solo si la orden se ha realizado durante el período de validez de la lista de precios y la entrega ha sido confirmada por el DISTRIBUIDOR por escrito dentro de un mes desde el fin del período de validez de la lista de precios según la cual se ha realizado el pedido.

Los horarios de las ventas previstas del PROVEEDOR garantizan el tiempo de entrega pero no garantizan el precio. El precio se fija de acuerdo con la lista de precios del PROVEEDOR (trimestralmente)

I. Reclamaciones

1. El DISTRIBUIDOR está obligado a comunicar al PROVEEDOR cualquier reclamación sobre la calidad del producto ofrecido por este último, por escrito, dentro de los tres días posteriores a la fecha en que dicha reclamación fue presentada por el cliente del DISTRIBUIDOR. Las reclamaciones son válidas solo si se presentan por escrito, ya que dicha forma escrita también es obligatoria para los clientes del DISTRIBUIDOR. Cada reclamación debe ir acompañada de fotografías del producto para el cual se ha presentado la queja, ya que se deben proporcionar evidencias de la causa de la reclamación y el código de producción del producto. Las reclamaciones por productos cuyo código de producción no sea claramente visible no serán respetadas por el PROVEEDOR.
2. El DISTRIBUIDOR está obligado a notificar al PROVEEDOR sin demora, a más tardar dentro de las 3 horas posteriores a la entrega - de cualquier incumplimiento del embalaje y la cantidad de los Productos entregados. El DISTRIBUIDOR está obligado a grabar la carta de porte, acompañando el envío. De lo contrario, el PROVEEDOR no será responsable de los daños causados por faltantes, embalaje dañado y / o daños durante el transporte.

- DE** A. Die Bestellungen, die die VERTEILER aufgeben, sind der Fa. Plexistab Bulgarien EAD, Tsarigradsko Shosse Str. 53, Plovdiv zu liefern; dieses Unternehmen sollte Rechnungen ausstellen.
- B. Alle Erzeugnisse werden gemäß den Geschäftsbedingungen ExW Plovdiv (ExW Plovdiv commercial terms) beladen und berechnet, inklusive Verpackung, wenn nicht anders schriftlich vereinbart.
- C. Alle Zahlungen werden in EURO geleistet.
- D. Alle Beträge für die jeweiligen Lieferungen werden auf das Bankkonto von Plexistab Bulgarien EAD überwiesen oder an eine in der Rechnung angegebenen Adresse gezahlt, gemäß den vereinten Zahlungsbedingungen. Dem LIEFERANTEN wird das Recht vorbehalten, bei Überziehung des Kreditrahmens Bestellungen abzusagen.
- F. Dem LIEFERANTEN wird das Recht vorbehalten, die Erfüllung einer Bestellung abzusagen, wenn der Rahmen des Zahlungsaufschubs überschritten worden ist.
- G. Die Waren werden nach INCOTERMS / Internationale Handelsbedingungen der ICC /
- H. Die Produktpreislisten werden alle sechs Monate aktualisiert und dem VERTEILER in schriftlicher Form, spätestens 20 Kalendertage vor dem Beginn der neuen Periode zur Verfügung gestellt. Die Lieferung wird gemäß der Preisliste der Vorperiode erfolgen, vorausgesetzt, dass die Bestellung während des Gültigkeitszeitraums der Preisliste aufgegeben worden ist und der VERTEILER die Lieferung schriftlich bestätigt hat, spätestens einen Monat nach Ablauf des Gültigkeitszeitraums der Preisliste, die für die Bestellung maßgeblich ist.

Der Verkaufsvoranschlag des LIEFERANTEN stellt die Lieferzeit sicher, er stellt jedoch nicht den Preis sicher. Der Preis wird gemäß der Preisliste des LIEFERANTEN (quartalweise) festgesetzt.

I. Rügen

1. Der VERTEILER soll dem LIEFERANTEN jeweilige Rügen hinsichtlich der Qualität der von ihm angebotenen Produkte schriftlich mitteilen, spätestens 3 Tage nach der Vorlage der Reklamation eines Kunden des VERTEILERS. Die Rügen sind nur in Schriftform rechtswirksam, das gilt auch für die Kunden des VERTEILERS. Jeder Rüge sollen Fotos des beanstandeten Produkts beigelegt werden, die den Grund dafür nachweisen, sowie den Produktionscode angeben. Warenbeanstandungen ohne erkennbaren Produktionscode werden vom VERTEILER nicht berücksichtigt.
2. Der VERTEILER soll dem LIEFERANTEN die Nonkonformität der Verpackung und Liefermenge der gelieferten Waren unverzüglich – binnen 3 Stunden nach Entladung der Lieferung mitteilen. Der VERTEILER soll jeweilige Mängel, Verpackungsbeschädigungen und Transportschäden im Ladeschein (CMR) eintragen. Anderenfalls entfällt die Haftung des LIEFERANTEN für Schäden, die sich aus Mängeln, Verpackungsbeschädigungen und/oder Transportschäden ergebend sind.

- DE** A. Заявки, сделанные ДИСТРИБЬЮТОРАМИ, следует отправлять по адресу, и счета - фактуры должны быть выданы компанией ЕАО „Плексистаб Болгария“, бул. „Цариградско Шоше“ 53, г. Пловдив.
- B. За исключением случаев наличия иной договоренности в письменном виде, отгрузка и выдача счетов-фактур на все товары осуществляется согласно торговым условиям ExW Пловдив (ExW Plovdiv commercial terms), которые включают упаковку.
- C. Все платежи производятся в Евро.
- D. Все платежи, за каждую отдельную поставку, осуществляются на банковский счет ЕАО „Плексистаб Болгария“ или по адресу, специально указанному в счете-фактуре, согласно уточненным условиям платежа. ПОСТАВЩИК оставляет за собой право отказаться выполнить заказ, в случае превышения кредитного лимита.
- F. ПОСТАВЩИК оставляет за собой право отказаться выполнить заказ, в случае превышения лимита отложенного платежа.
- G. Перевозка товара осуществляется согласно условиям INCOTERMS / Международные Коммерческие Условия /
- H. Прайс-листы на Товары подлежат актуализации каждые 6 месяцев и предоставляются ДИСТРИБЬЮТОРУ в письменном виде, не позднее 20 календарных дней до начала нового периода. Поставка будет выполнена в соответствии с условиями прайс-листа за предшествующий период, только при условии, что заявка подана в период действия прайс-листа и поставка подтверждена ДИСТРИБЬЮТОРОМ в письменном виде, не позднее одного месяца после истечения периода действия прайс-листа, согласно которому сделан заказ.

План прогнозируемых продаж ПОСТАВЩИКА гарантирует время поставки, но не гарантирует цену. Цена определяется в зависимости от прайс-листа ПОСТАВЩИКА (на основе трехмесячного периода)

I. Жалобы

1. ДИСТРИБЬЮТОР должен уведомить ПОСТАВЩИКА о каждой рекламации по поводу качества предлагаемых последним товаров письменно, не позднее 3 дней от даты поступления рекламации от клиента ДИСТРИБЬЮТОРА. Для рекламаций действительной является только письменная форма, которая прилагается обязательно и в отношении клиентов ДИСТРИБЬЮТОРА. К каждой рекламации обязательно прилагаются фотографии товара, на который предъявляется рекламация, и на которых видно основание для рекламации и производственный код товара. Рекламации товаров без ясно различимого производственного кода не будут удовлетворяться ПОСТАВЩИКОМ.
2. ДИСТРИБЬЮТОР должен уведомить ПОСТАВЩИКА незамедлительно, не позднее 3 часов от разгрузки поставки, обо всех несоответствиях в упаковке и количестве поставленных товаров. ДИСТРИБЬЮТОР должен отметить недостачу, нарушения целостности упаковки и повреждения при транспортировке в CMR (товаротранспортная накладная), сопровождающей груз. В противном случае ПОСТАВЩИК не несет ответственности за ущербы, возникшие в результате недостач, нарушения целостности упаковки и/или повреждений при перевозке.

Chemical Resistance Guide

Spiral Reinforced Flexible Hoses

FR GUIDE POUR LA RÉSISTANCE CHIMIQUE TUYAUX FLEXIBLES RENFORCÉS PAR SPIRALE
ES GUÍA DE RESISTENCIA QUÍMICA MANGUERAS FLEXIBLES REFORZADAS ESPIRAL
DE ANLEITUNG CHEMIKALIENBESTÄNDIGKEIT WELLSCHLÄUCHE SPIRALVERSTÄRKT
RU РУКОВОДСТВО ПО ХИМИЧЕСКОЙ СТОЙКОСТИ ГИБКИХ ШЛАНГОВ, УСИЛЕННЫХ СПИРАЛЬЮ

EN This is an indicative list intended for general guidance only.
The information furnished hereby is based on our best knowledge and experience.
No warranty can be given as much depends upon the exact working conditions of each case

1. Satisfactory.
2. Recommended for the service and conditions shown for Oil Hose.
3. The material may be considered for use when alternative materials are unsatisfactory and where limited life is acceptable.

When PVC is to be used with such chemicals full-scale trials under realistic conditions are particularly necessary.

4. Unsatisfactory.

FR Ceci est une liste indicative destinée uniquement aux instructions générales.
Les informations fournies ici sont basées sur nos meilleures connaissances et expériences.
Aucune garantie ne peut être donnée dans la mesure où cela dépend des conditions de travail exactes de chaque application.

1. Satisfaisant.
2. Recommandé pour les applications et les conditions spécifiées pour un tuyau pour huiles.
3. Le matériel peut être considéré comme utilisable lorsque les matériaux de remplacement ne sont pas satisfaisants et lorsque la durée de vie limitée est acceptable.

Lorsque le PVC est utilisé avec de tels produits chimiques, il est particulièrement important de faire des tests d'essai complets dans des conditions réalistes.

4. Insatisfaisant

ES Esta es una lista indicativa destinada solo a la orientación general.
Esta información se basa en nuestro mejor conocimiento y experiencia.
No se puede otorgar ninguna garantía ya que depende de las condiciones de trabajo exactas según el caso

1. Satisfactorio.
2. Recomendado para el servicio y las condiciones indicadas para la manguera de aceite.
3. El material puede considerarse para uso cuando los materiales alternativos son insatisfactorios y cuando la vida limitada es aceptable.

Cuando el PVC se va a utilizar con tales sustancias químicas, los ensayos a gran escala en condiciones realistas son particularmente necesarios.

4. Insatisfactorio.

DE Dieses Verzeichnis ist beispielhaft und sollte nur zur allgemeinen Orientierung dienen.
Folgende Daten sind aufgrund unserer Kenntnisse und Erfahrung angegeben.

1. Ausreichend.
2. Wird für die bei Oil House angegebenen Leistungen und Bedingungen empfohlen.
3. Dieser Stoff ist einsetzbar in den Fällen, wenn die alternativen Stoffe nicht zufriedenstellend sind und wenn er für Lebewesenunzugänglich ist.

Bei Anwendung von PVC, die ähnliche Chemikalien halten, sind erweiterte Prüfungen unter realistischen Bedingungen unentbehrlich

4. Unzureichend.

RU Этот список является приблизительным, только для общей ориентации.
Приведенная ниже информация основана на наших знаниях и опыте.
Гарантия не дается, так как большое значение имеют точные рабочие условия в каждом конкретном случае.

1. Удовлетворительно.
2. Рекомендуется для услуг и условий, указанных в Oil Hose.
3. Материал может быть использован в том случае, при котором альтернативные материалы не удовлетворительны и когда имеет место лимитированный доступ живых существ.

В случаях использования ПВХ с подобными химикатами, детальные исследования при реалистичных условиях особенно необходимы.

4. Неудовлетворительно.

CHEMICAL	CONCENTRATION	CONDITIONS	
		20°C	60°C
Acetic Acid	10%	1	1
Acetic Acid	60%	1	3
Acetic Acid	Glacial	4	4
Acetic Anhydride		4	4
Aceton	Traces	4	4
Aceton	100%	4	4
Adipic acid			
Alcohol allyl		4	4
Alcohol allyl	40% w/w water	1	
Alcohol allyl	100%	1	
Alcohol isopropyl		1	
Alcohol methyl	6% aq.sol.	1	
Alcohol methyl	100%	3	
Aluminium salts		1	1
Allyl chloride		4	4
Ammonia	0,88 s.g.aq.soln	1	
Ammonia	Dry gas	1	
Ammonia	Liquid	4	
Ammonium hydroxide		1	
Ammonium salts		1	1
Ammonium sulfide		1	4
Aniline		4	4
Animal oils		1	1
Barium salts		1	1
Beer		1	
Benzaldehyde	Traces	4	4
Benzaldehyde	100%	4	4
Benzene		4	4
Borax		1	
Brine		1	1
Bromine	Gas, Traces	4	4
Bromine	100% Dry Gas	4	4
Bromine	Liquid	4	4
Butane		1	1
Butanol		1	3
Butyl acetate		4	4
Butyric acid	20% aq.soln.	1	
Butyric acid	Conc.	4	4
Calcium hydroxide		1	
Calcium hypochlorite		1	
Calcium salts		1	1
Carbon dioxide		1	1
Carbon disulphide		4	4
Carbon monoxide		1	1
Carbon tetrachloride		4	4
Cesein		1	1
Chlorine	10% (dry gas)		
Chlorine	100% (dry gas)		
Chlorine	10% (moist gas)		
Chlorine	Sat. Soln	3	4

CHEMICAL	CONCENTRATION	CONDITIONS	
		20°C	60°C
Chlorobenzene		4	4
Chloroform		4	4
Chlorosulfonic acid		4	4
Chromic acid	Plating soln	4	4
Chromic acid	Conc.		
Citric acid		1	
Copper salts		1	1
Cycloexanol		4	4
Cycloexanone		4	4
Detergents, Synthetic	All conc.	1	
Developers photograph		1	1
Dextrose		1	1
Dichlorethylene		4	4
Dichlorobenzene		4	4
Diesel Oil		2	2
Diethyl ether		4	4
Dimethylamine			
Emulsifiers	All conc.	1	1
Emulsions photograph.		1	1
Ether		4	4
Ethyl acetate		4	4
Ethylene dichloride		4	4
Ethylene Glycol		1	
Fatty acids			
Ferric salts		1	1
Fixing solution, photog.		1	1
Fluorine		4	4
Formaldehyde	40% w/w in wat.	1	
Formic acid	40%	1	1
Formic acid	50%	3	4
Formic acid	100%	4	4
Glucose		1	1
Glycerine		1	
Grape sugar		1	1
Hydrochloric acid	10% aq.soln.	1	1
Hydrochloric acid	22%	1	3
Hydrochloric acid	Conc.	1	3
Hydrochloric acid	4% aq.soln.	1	1
Hydrochloric acid	40% aq.soln.	1	
Hydrochloric acid	60% aq.soln.	4	4
Hydrochloric acid	Conc.	4	4
Hydrogen		1	1
Hydrogen bromide anhydrous		1	
Hydrogen chloride anhyd.		1	
Hydrogen fluoride		1	
Hydrogen peroxide	3% (10 vol)	1	
Hydrogen peroxide	12% (40 vol)	1	
Hydrogen peroxide	30% (100 vol)	1	
Hydrogen peroxide	90% and above	1	

CHEMICAL	CONCENTRATION	CONDITIONS	
		20°C	60°C
Hydrogen sulphite		1	
Iodine	Soln in potass.		
Iodine	Iodide	4	4
Lactic acid	10%	1	
Lactic acid	100%	4	4
Laquer solvents		3	4
Lauric acid		1	
Lauryl alcohol		1	
Lead salts		1	1
Magnesium salts		1	1
Manganese dioxide	Conc. soln.	1	1
Mercuric chloride		4	4
Methyl chloride		4	4
Methyl ethyl ketone		4	4
Methylene chloride		4	4
Milk		1	
Mineral oils		2	2
Mixed acids (sulphuric / nitric)			
Various proportions			4
Molasses		1	1
Naphta		4	4
Naphtalene		4	4
Nickel salts	10%	1	1
Nitric acid	25%	1	
Nitric acid	50%	1	
Nitric acid	70%	1	3
Nitric acid	95%	3	4
Nitric acid		4	4
Nitrobenzene		4	4
Nitrogen fertilizers	Moist	1	
Nitrous fumes			4
Oleic acid		1	
Oxalic acid		1	1
Oxygen		1	1
Ozon		1	
Palmitic acid		1	
Paraffin		3	
Petrol	80:20	2	2
Petrol benzene mixt		4	4
Phenol	20% aq. Soln		4
Phosphoric acid	30% aq. Soln	1	1
Phosphoric acid		1	1
Photografic developers		1	1
Photografic emulsions		1	1
Phot. fixing sol.	1% w/w in wat	1	1
Picric acid	10% w/w in alc.	1	1
Picric acid	1% aq. Soln	1	
Potassium hydroxide	10% aq. Soln	1	1

CHEMICAL	CONCENTRATION	CONDITIONS	
		20°C	60°C
Potassium hydroxide	Conc. aq. Soln	1	1
Potassium hydroxide		1	4
Potassium salts		1	1
Propane		2	2
Propylene dichloride		4	4
Salicylic acid		1	1
Sea water		1	1
Soap solution		1	
Sodium hydroxide	1% aq. Soln	1	
Sodium hydroxide	10% aq. Soln	1	3
Sodium hydroxide	40% aq. Soln	1	4
Sodium hydroxide	Conc. aq. Soln	1	4
Sodium hypochlorite	15% act. cl.	1	3
Sodium salts		1	1
Sulphur dioxide	Dry gas	1	1
Sulphur dioxide	Moist	1	3
Sulphur dioxide	Liquid	3	4
Sulphuric acid	10%	1	1
Sulphuric acid	45%	1	1
Sulphuric acid	50%	1	1
Sulphuric acid	60%	3	3
Sulphuric acid	98%	4	4
Sulphuric acid	Fuming	4	4
Sulphurous acid	30%	1	
Tallow		1	
Tannic acid		1	
Tanning extracts		1	
Tartaric acid		1	
Tetraethyl lead		1	
Tetrahydrofuran		4	4
Tetralin		4	4
Toluene		4	4
Transformer oil		2	4
Trichlorethane		4	4
Triethanolamine		4	4
Trichlorethylene		1	1
Triethylamine			
Turpentine			
Urea		1	
Vegetable oils		1	
Vinegar		1	
Vinyl acetate		4	4
Water		1	1
Wetting agents	All conc.	1	1
Wines & spirits		1	1
Xylene		4	4
Zink salts		1	1









Information for transportation

FR INFORMATIONS POUR LE TRANSPORT
ES INFORMACIÓN SOBRE EL TRANSPORTE

DE INFORMATIONEN FÜR DEN TRANSPORT
RU ИНФОРМАЦИЯ ДЛЯ ТРАНСПОРТА









BULFLEX

SERIES F006N/Z, F008N/S, F011N/S, F015S





							
mm	inch	Roll volume 25m	Pallet dimention	Rolls per pallet	Roll volume 50m	Pallet dimention	Rolls per pallet
13	1/2	0.038	1.2m x 1.2m	60	0.023	1m x 1m	100
16	5/8	0.045	1.2m x 1.2m	60	0.030	1m x 1m	80
19	3/4	0.076	1.2m x 1.2m	36	0.037	1.2m x 1.2m	80
20		0.079	1.2m x 1.2m	36	0.039	1.2m x 1.2m	80
25	1	0.100	0.8m x 0.8m	15	0.048	1.2m x 1.2m	60
30		0.150	0.9m x 0.9m	13	0.075	1.2m x 1.2m	36
32	1 1/4	0.150	0.9m x 0.9m	12	0.080	1.2m x 1.2m	36
35		0.170	0.9m x 0.9m	12	0.100	0.8m x 0.8m	14
38	1 1/2	0.230	0.9m x 0.9m	10	0.120	0.8m x 0.8m	13
40		0.240	0.9m x 0.9m	8	0.130	0.8m x 0.8m	12
45	1 3/4	0.290	1m x 1m	9	0.170	0.9m x 0.9m	10
51	2	0.360	1m x 1m	8	0.190	0.9m x 0.9m	10
55		0.370	1m x 1m	8	0.210	0.9m x 0.9m	10
60		0.470	1.3m x 1.3m	8	0.250	1m x 1m	12
63	2 1/2	0.510	1.3m x 1.3m	8	0.280	1m x 1m	12
70		0.630	1.4m x 1.4m	7	0.350	1.2m x 1.2m	10
76	3	0.670	1.4m x 1.4m	7	0.370	1.2m x 1.2m	9
80		0.830	1.4m x 1.4m	7	0.470	1.2m x 1.2m	8
90	3 1/2	0.920	1.6m x 1.6m	5	0.520	1.3m x 1.3m	7
102	4	1.200	1.6m x 1.6m	5	0.670	1.4m x 1.4m	7
110	4 1/4	1.620			0.840		
120					1.030		
127	5				1.080		
152	6				1.600		

BULFLEX

SERIES F021N, F032N, F010SSZ/M, F022NP, F042NP, F010N/S

							
mm	inch	Roll volume 25m	Pallet dimention	Rolls per pallet	Roll volume 50m	Pallet dimention	Rolls per pallet
19	3/4	0.076	15	0.8m x 0.8m	0.037	1.2m x 1.2m	80
20		0.079	15	0.8m x 0.8m	0.039	1.2m x 1.2m	80
25	1	0.100	15	0.8m x 0.8m	0.048	1.2m x 1.2m	60
30		0.150	14	0.9m x 0.9m	0.075	1.2m x 1.2m	30
32	1 1/4	0.150	13	0.9m x 0.9m	0.080	1.2m x 1.2m	30
35		0.170	12	0.9m x 0.9m	0.100	0.8m x 0.8m	14
38	1 1/2	0.230	10	0.9m x 0.9m	0.120	0.8m x 0.8m	13
40		0.240	8	1m x 1m	0.130	0.8m x 0.8m	12
45	1 3/4	0.290	9	1m x 1m	0.170	0.8m x 0.8m	10
51	2	0.360	8	1m x 1m	0.190	0.9m x 0.9m	10
55		0.370	8	1m x 1m	0.210	0.9m x 0.9m	10
60		0.470	7	1.3m x 1.3m	0.250	1.1m x 1.1m	11
63	2 1/2	0.510	7	1.4m x 1.4m	0.280	1.1m x 1.1m	11
70		0.630	6	1.3m x 1.3m	0.350	1.1m x 1.1m	10
76	3	0.670	6	1.6m x 1.6m	0.370	1.2m x 1.2m	8
80		0.830	6	1.6m x 1.6m	0.470	1.2m x 1.2m	8
90	3 1/2	0.920	5	1.4m x 1.4m	0.520	1.3m x 1.3m	6
102	4	1.200	5	1.4m x 1.4m	0.670	1.2m x 1.2m	6
110	4 1/4	1.620			0.840		
120					1.030		
127	5				1.080		
152	6				1.600		









SERIES F120N, F161N/W

				
mm	inch	Roll volume 25m	Pallet dimention	Rolls per pallet
13	1/2	0.023	100	1m x 1m
16	5/8	0.030	80	1m x 1m
19	3/4	0.037	80	1m x 1m
20		0.039	80	1.2m x 1.2m
25	1	0.048	60	1.2m x 1.2m
30		0.075	30	1.2m x 1.2m
32	1 1/4	0.080	30	1.2m x 1.2m
35		0.100	14	0.8m x 0.8m
38	1 1/2	0.120	13	0.8m x 0.8m
40		0.130	12	0.8m x 0.8m
45	1 3/4	0.170	10	0.8m x 0.8m
51	2	0.190	10	0.9m x 0.9m
55		0.210	10	0.9m x 0.9m
60		0.250	12	1m x 1m
63	2 1/2	0.280	12	1m x 1m
70		0.350	10	1.2m x 1.2m
76	3	0.370	9	1.2m x 1.2m
80		0.470	8	1.2m x 1.2m
90	3 1/2	0.520	7	1.3m x 1.3m
102	4	0.670	7	1.4m x 1.4m
110	4 1/4	0.840		
120		1.030		
127	5	1.080		
140		1.500		
152	6	1.600		

SERIES F130N/W, 131W

				
mm	inch	Roll volume 25m	Pallet dimention	Rolls per pallet
10			1m x 1m	140*
13	1/2	0.023	1m x 1m	140*
16	5/8	0.030	1m x 1m	100*
18		0.033	1m x 1m	80* * 5 rolls in a bag
19	3/4	0.037	1m x 1m	80* ** 4 rolls in a bag
20		0.039	1m x 1m	80**
25	1	0.048	1.2m x 1.2m	60
30		0.075	1.2m x 1.2m	30
32	1 1/4	0.080	1.2m x 1.2m	30
35		0.100	0.8m x 0.8m	14
38	1 1/2	0.120	0.8m x 0.8m	13
40		0.130	0.8m x 0.8m	12
45	1 3/4	0.170	0.9m x 0.9m	11
50		0.190	0.9m x 0.9m	10
51	2	0.190	0.9m x 0.9m	10
55		0.210	0.9m x 0.9m	10

SERIES F180G/W

							
mm	inch	Roll volume 25m	Pallet dimention	Rolls per pallet	Roll volume 50m	Pallet dimention	Rolls per pallet
20		0.022	1.2m x 1.2m	80		1.2m x 1.2m	60
25	1	0.032	1m x 1m	80		1.2m x 1.2m	40
32	1 1/4	0.052	1.2m x 1.2m	40		0.8m x 0.8m	14
40		0.100	0.8m x 0.8m	15	0.174	0.9m x 0.9m	8
51	2	0.130	0.8m x 0.8m	11	0.259	1.2m x 1.2m	10
63	2 1/2	0.259	1.2m x 1.2m	12		1.2m x 1.2m	8
76	3	0.330	1.2m x 1.2m	9		1.2m x 1.2m	7
90	3 1/2	0.380	1.2m x 1.2m	8			

BULVYL

SERIES 302N

mm	inch	Roll volume 25m	Pallet dimention	Rolls per pallet	Roll volume 50m	Pallet dimention	Rolls per pallet
13	1/2	0.020	1.2m x 1.2m	60	0.040	1.2m x 1.2m	50
16	5/8	0.025	1m x 1m	40	0.050	1.2m x 1.2m	40
19	3/4	0.030	1m x 1m	40	0.060	1.2m x 1.2m	40
25	1	0.050	1.2m x 1.2m	40	0.092	0.9m x 0.9m	10

SERIES 320N

mm	inch	Roll volume 25m	Pallet dimention	Rolls per pallet	Roll volume 50m	Pallet dimention	Rolls per pallet
6	1/4	0.020	1m x 1m	80	0.030	1.2m x 1.2m	60
8	5/16	0.025	1m x 1m	80	0.035	1.2m x 1.2m	60
10	3/8	0.030	1m x 1m	80	0.040	1.2m x 1.2m	60
13	1/2	0.035	1.2m x 1.2m	60	0.044	1.2m x 1.2m	50
16	5/8	0.040	1m x 1m	40	0.050	1.2m x 1.2m	40
19	3/4	0.050	1m x 1m	40	0.078	1.2m x 1.2m	40
25	1	0.080	1.2m x 1.2m	40	0.109	0.9m x 0.9m	10
32	1 1/4				0.168	1.1m x 1.1m	8
38	1 1/2				0.235	1.1m x 1.1m	5
51	2				0.400	1.1m x 1.1m	4

SERIES 340N, 380N

mm	inch	Roll volume 25m	Pallet dimention	Rolls per pallet	Roll volume 50m	Pallet dimention	Rolls per pallet
6	1/4				0.030	1.2m x 1.2m	60
8	5/16				0.031	1.2m x 1.2m	60
10	3/8				0.032	1.2m x 1.2m	60
13	1/2				0.044	1.2m x 1.2m	50
16	5/8				0.050	1.2m x 1.2m	40
19	3/4				0.078	1.2m x 1.2m	40









BULFLAT

SERIES 204N, 206N

mm	inch	Roll volume 25m	Pallet dimention	Rolls per pallet	Roll volume 50m	Pallet dimention	Rolls per pallet
25	1	0.035	1.2m x 1.2m	100	0.045	0.9m x 0.9m	25
30		0.036	1.2m x 1.2m	100	0.045	0.9m x 0.9m	20
32	1/1.4	0.036	1.2m x 1.2m	100	0.045	0.9m x 0.9m	20
35		0.039	1.2m x 1.2m	80	0.053	0.9m x 0.9m	20
38	1 1/2	0.039	1.2m x 1.2m	80	0.053	0.9m x 0.9m	20
40		0.046	1.2m x 1.2m	80	0.060	0.9m x 0.9m	15
45	1 3/4	0.046	1.2m x 1.2m	70	0.060	0.9m x 0.9m	15
51	2	0.052	1.2m x 1.2m	60	0.068	0.9m x 0.9m	15
55	2	0.054	1.2m x 1.2m	60	0.068	0.9m x 0.9m	15
60		0.054	1.2m x 1.2m	60	0.068	0.9m x 0.9m	15
63	2 1/2	0.061	1.2m x 1.2m	50	0.079	0.9m x 0.9m	12
70		0.069	1.2m x 1.2m	50	0.087	0.9m x 0.9m	12
76	3	0.077	1.2m x 1.2m	40	0.097	0.9m x 0.9m	10
80		0.091	1.2m x 1.2m	40	0.119	0.9m x 0.9m	10
90	3 1/2	0.098	1.2m x 1.2m	40	0.128	0.9m x 0.9m	10
102	4	0.117	1.2m x 1.2m	30	0.148	0.9m x 0.9m	10
127	5	0.161	1.2m x 1.2m	30	0.205	1m x 1m	8
153	6	0.206	0.8m x 0.8m	7	0.258	1m x 1m	6
203	8	0.248	0.8m x 0.8m	5	0.323	1m x 1m	5









BULFLAT

SERIES 208N, 210N

									
mm	inch	Roll volume 25m	Pallet dimension	Rolls per pallet	Roll volume 50m	Pallet dimension	Rolls per pallet		
25	1	0.030	1.20m x 1.20m	80	0.040	1.1m x 1.1m	25		
30		0.039	1.20m x 1.20m	80	0.048	1.1m x 1.1m	20		
32	1/1.4	0.037	1.20m x 1.20m	72	0.048	1.1m x 1.1m	20		
35		0.042	1.20m x 1.20m	70	0.057	1.1m x 1.1m	20		
38	1 1/2	0.043	1.20m x 1.20m	70	0.057	1.1m x 1.1m	20		
40		0.049	1.20m x 1.20m	70	0.066	1.1m x 1.1m	15		
45	1 3/4	0.049	1.20m x 1.20m	50	0.066	1.1m x 1.1m	15		
51	2	0.055	1.20m x 1.20m	50	0.074	1.1m x 1.1m	15		
55		0.062	1.20m x 1.20m	50	0.083	1.1m x 1.1m	15		
60		0.062	1.20m x 1.20m	48	0.092	1.1m x 1.1m	15		
63	2 1/2	0.072	0.8m x 0.8m	12	0.101	1.1m x 1.1m	12		
70		0.082	0.8m x 0.8m	12	0.110	1.1m x 1.1m	12		
76	3	0.091	0.8m x 0.8m	12	0.131	1.1m x 1.1m	10		
80		0.099	0.8m x 0.8m	10	0.141	1.1m x 1.1m	10		
90	3 1/2	0.114	0.8m x 0.8m	10	0.162	1.1m x 1.1m	10		
102	4	0.142	0.9m x 0.9m	5	0.227	1.1m x 1.1m	10		
127	5	0.158	0.9m x 0.9m	5	0.233				
153	6	0.200	0.9m x 0.9m	5	0.294				
203	8	0.257	0.9m x 0.9m	4	0.380				

BULFLAT

SERIES 216N

									
mm	inch	Roll volume 25m	Pallet dimension	Rolls per pallet	Roll volume 50m	Pallet dimension	Rolls per pallet		
25	1	0.035	0.8m x 0.8m	20	0.050	1.1m x 1.1m	25		
30		0.041	0.8m x 0.8m	20	0.051	1.1m x 1.1m	20		
32	1/1.4	0.042	0.8m x 0.8m	18	0.058	1.1m x 1.1m	20		
35		0.045	0.8m x 0.8m	17	0.063	1.1m x 1.1m	20		
38	1 1/2	0.049	0.8m x 0.8m	15	0.068	1.1m x 1.1m	20		
40		0.052	0.8m x 0.8m	14	0.073	1.1m x 1.1m	15		
45	1 3/4	0.056	0.8m x 0.8m	13	0.080	1.1m x 1.1m	15		
51	2	0.066	0.8m x 0.8m	13	0.082	1.1m x 1.1m	15		
55		0.075	0.8m x 0.8m	13	0.091	1.1m x 1.1m	15		
60		0.079	0.8m x 0.8m	12	0.116	1.1m x 1.1m	15		
63	2 1/2	0.085	0.8m x 0.8m	12	0.124	1.1m x 1.1m	12		
70		0.094	0.8m x 0.8m	10	0.137	1.1m x 1.1m	12		
76	3	0.100	0.8m x 0.8m	10	0.141	1.1m x 1.1m	10		
80		0.105	0.8m x 0.8m	10	0.164	1.1m x 1.1m	10		
90	3 1/2	0.121	0.8m x 0.8m	10	0.174	1.1m x 1.1m	10		
102	4	0.161	0.8m x 0.8m	10	0.207	1.1m x 1.1m	10		
127	5	0.175	0.8m x 0.8m	5	0.650				
153	6	0.219	0.8m x 0.8m	4	0.710				
203	8	0.290	0.8m x 0.8m	4	0.799				

Storage and Transportation

SMALL ADVICES WITH A BIG IMPACT

UV protection

Even though the folio used for packaging is UV protected, it is fatal to leave the rolls at direct sun light for a long time. Might lead to deformation of the spiral.

Bending radius

In case of disassembling a roll to cut from it always keep in mind the correct bending radius when rolling it back.

Store on pallets

Even if you receive your stock without pallets, always store in ON pallets.

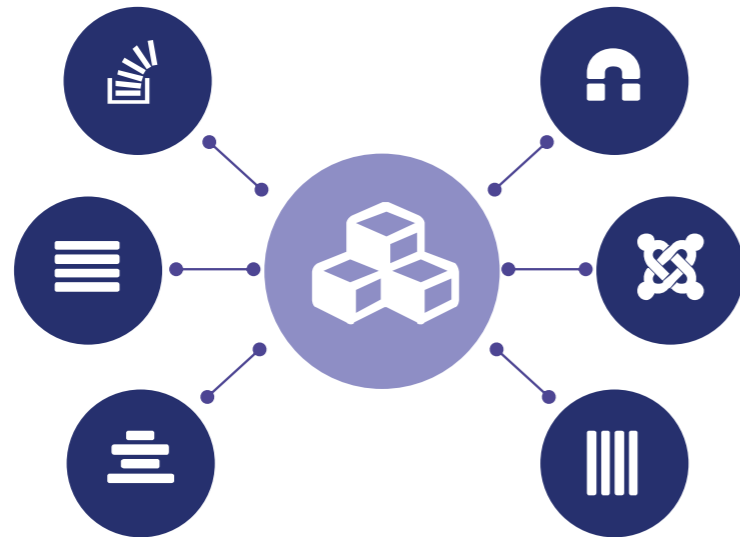

Friction during transportation

When transporting the goods to customers arrange the stock in a way that will prevent friction between the rolls and with the walls of the truck.

Correct height limit

Be careful about the high of the pallet, on with the hoses are stored. A very high column can cause deformations in the bottom roll. Also rolls need to be with the same diameter.

No vertical placement

Never store a roll in vertical position. It will cause the roll to get crushed/ deformed.





**Flexible
Reliable
Durable**

www.plexistab.com

Contact us:

53 Tsarigradsko shose Blvd.
4006 Plovdiv, Bulgaria

+ 359 32 652 018
office@plexistab.com